

*SELF structural elements*

Drainage channels,  
boot scrapers,  
yard sumps for the house,  
yard and garden



- 04** ***ANRIN SELF structural elements***  
Material/Application/Properties
- 08** ***SELF drainage channels***  
with slotted steel grating and snap fastening
- 10** ***SELF drainage channels***  
with slotted top
- 12** ***SELF comfort boot scrapers***
- 14** ***SELF drainage yard sump***

Drainage of terraces



## ***ANRIN – the drainage system***

At our production and logistics centre located in Anröchte, North Rhine Westphalia, we have been developing and producing pioneering drainage systems made of resin concrete and cover gratings for all physical and artistic demands of modern drainage around your house, yard and garden since 1971.

Thanks to our especially efficient distribution, we are able to supply any construction site in Germany in less than 48 hours as well as many other countries within just a few days. Always new, creative and patented channel and grating systems give our demanding construction managers, architects, tradesmen and specialist dealers the safe and secure feeling that they have made the right choice for the long term.

Millions of metres of installed channel and certification in accordance with DIN EN ISO 9001:2008 assure the high quality of our owner-operated family company. We place a special emphasis on technical and application-based consultation, with the goal of continuously finding the best solution for your individual construction project. Contact us and put our expertise to the test.



**ANRIN SELF  
structural elements  
made of resin concrete**

The material comprised of naturally occurring mineral quartzes and resin is distinguished by its structural and environmental benefits. In comparison with conventional, cement-bound materials, resin concrete allows for unit weights which are much easier to handle.

By processing the material on the construction site, time and money are saved.

The high quality of the individual components as well as the closed material matrix make the ANRIN resin concrete watertight and highly resistant to corrosion as well as a number of substances.

As a result, surfaces can be designed which purposefully drain off rainwater and the ground water can be reliably protected against environmental pollution.

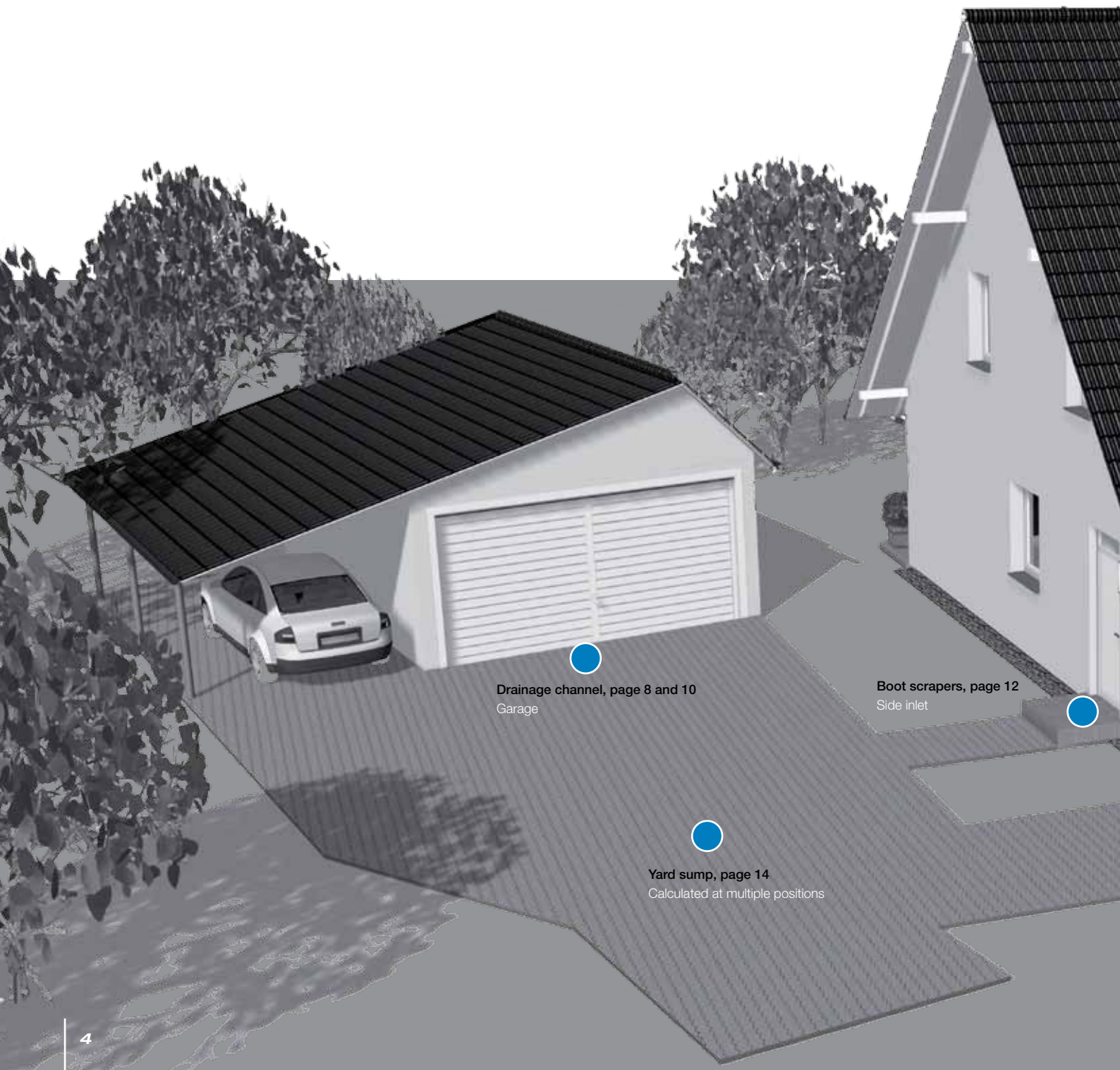

Drainage channel, page 8 and 10  
Garage

Boot scrapers, page 12  
Side inlet

Yard sump, page 14  
Calculated at multiple positions

**Tip**

Always incorporate channel or point drainage into the planning of the surfaces surrounding your house in order to prevent dammed-up water, ponding and the associated later structural damages.

**ANRIN DIRECT CONTACT: +49 (0) 29 47.97 81-0**

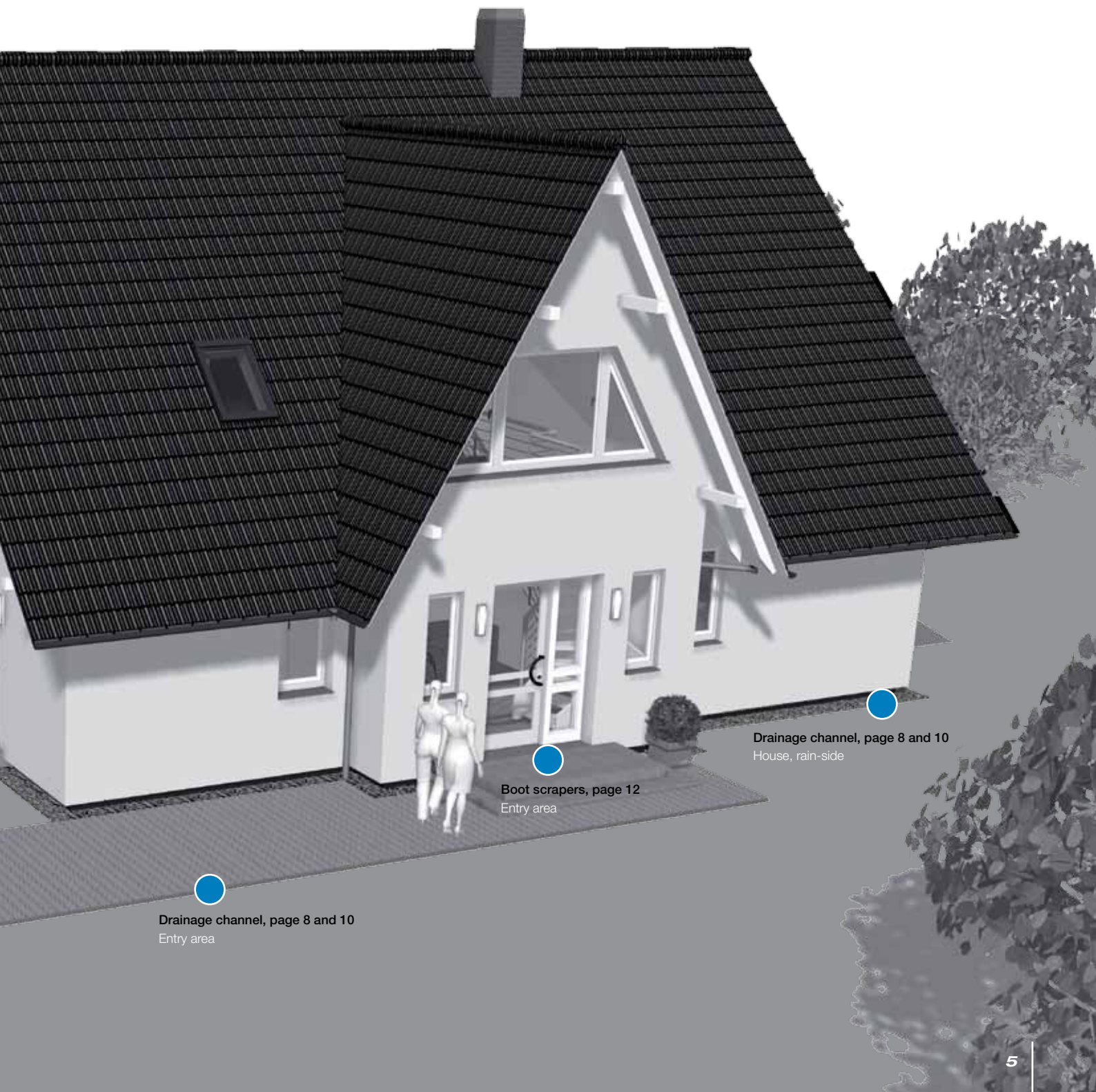

Drainage channel, page 8 and 10  
Entry area

Boot scrapers, page 12  
Entry area

Drainage channel, page 8 and 10  
House, rain-side

**UNILINK® joint**

The optimised **UNILINK®** joint system eliminates the traditional differentiation between the beginning and end of the channel. Elements with an equal installation height can be joined in any arbitrary direction. The symmetrically divided half-joints enable the optional sealing of the splicing. Vertically aligned grooves and tongues support an efficient installation: In the process, the installation alignment can be chosen arbitrarily! The flexibility in the design and installation phases enters a new dimension with the **UNILINK®** joint!

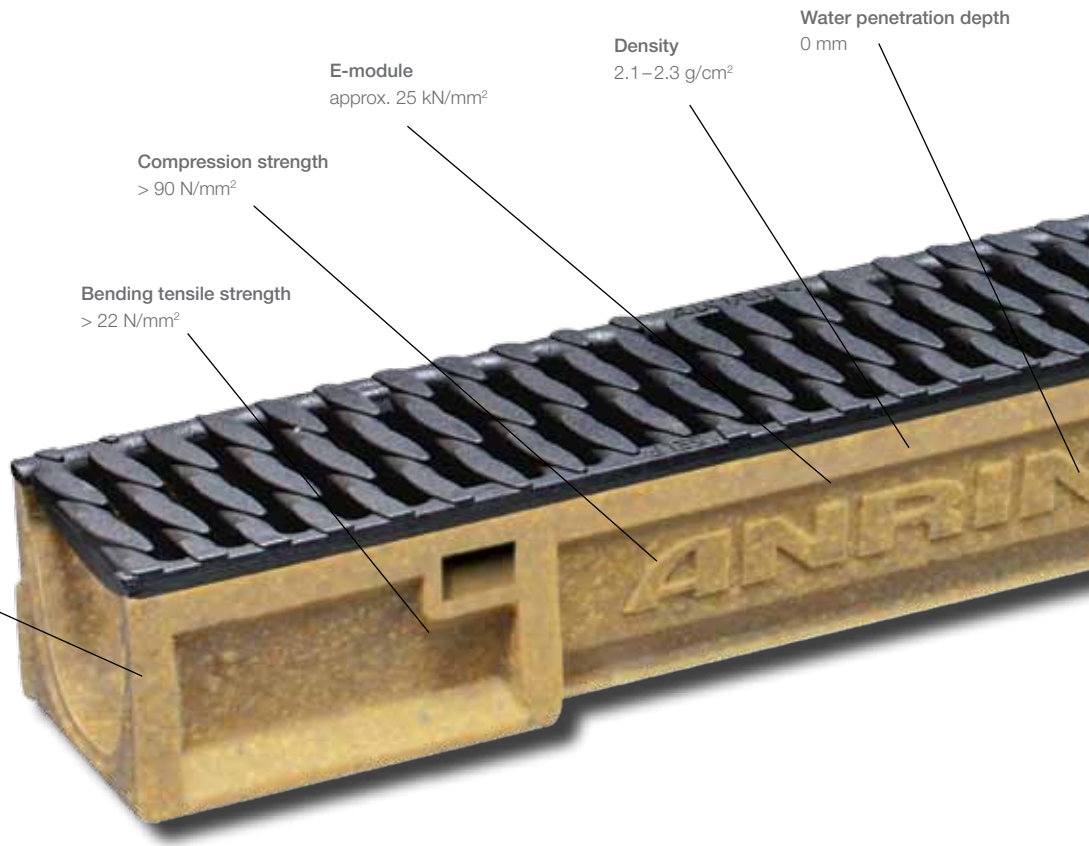

- 1 Garage entrance
- 2 Balcony
- 3 Path boundary
- 4 House entrance
- 5 Courtyard
- 6 Garden



**Cover gratings**  
Classic slotted steel grating in galvanised steel, stainless steel, plastic or ductile cast iron

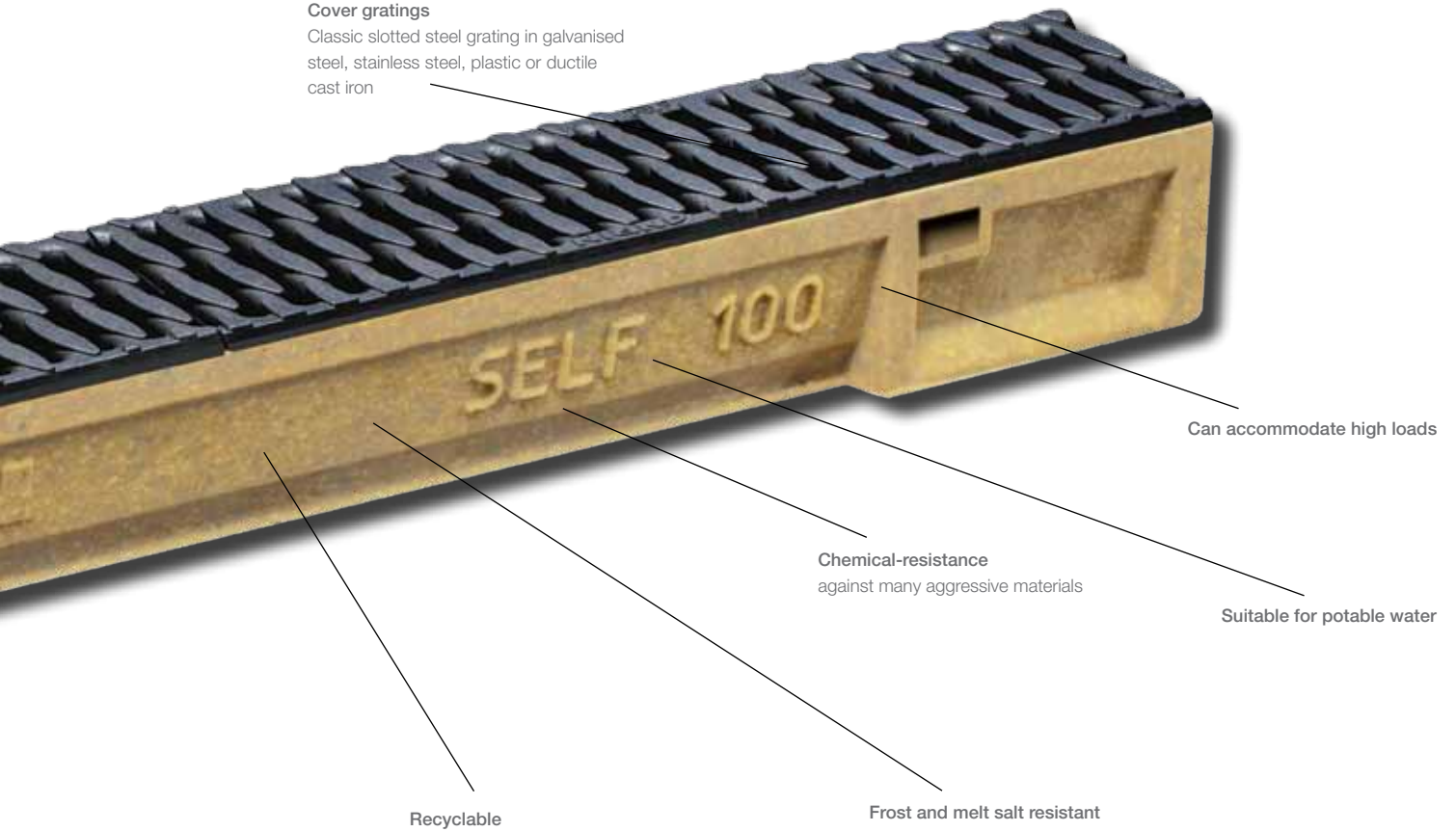

**SELF-100, SELF-ECO  
and SELF-Mini**





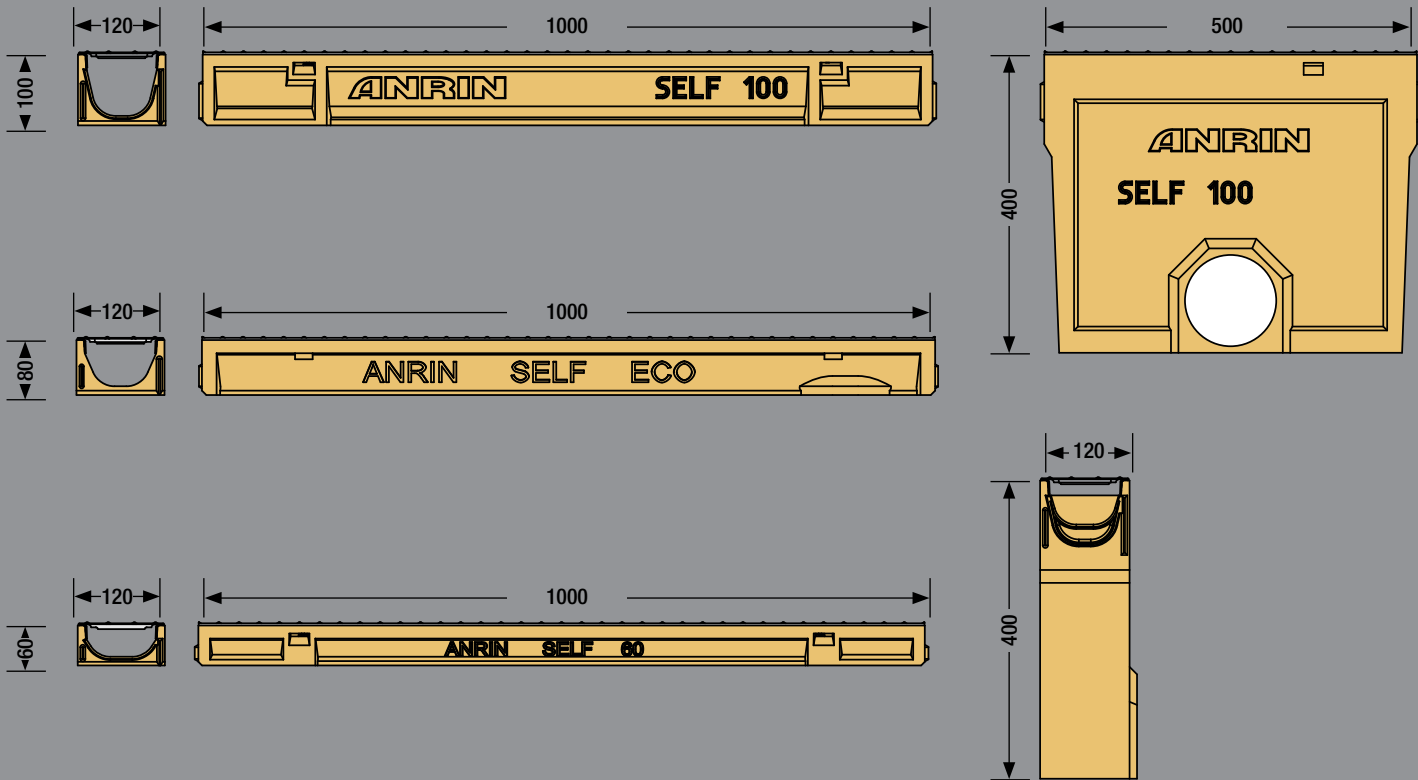

- ① **SELF-100**
- ② **SELF-ECO**
- ③ **SELF-Mini**
- ④ **End cap**  
with DA/OD 110 pipe socket
- ⑤ **End cap**
- ⑥ **Sump unit**
- ⑦ **Foul air trap**  
DA/OD 110
- ⑧ **Pipe sockets**  
DA/OD 110







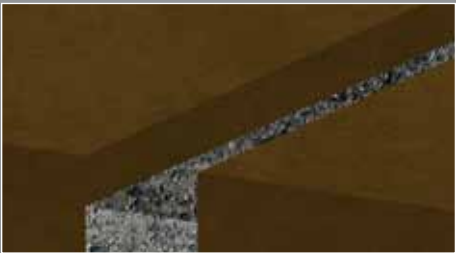

<b>Product specifications</b>	<b>SELF-100</b>	<b>SELF-ECO</b>	<b>SELF-Mini</b>	<b>Sump unit</b>
Material	Resin concrete	Resin concrete	Resin concrete	Resin concrete
Length	50/100 cm	50/100 cm	100 cm	50 cm
Width	12 cm	12 cm	12 cm	12 cm
Height	10 cm	8 cm	6 cm	40 cm
Weight	4.5/8.0 kg	3.2/6.3 kg	6.3 kg	15.5 kg
Nominal width	10 cm	10 cm	10 cm	10 cm
Joint type	UNILINK® joint	UNILINK® joint	UNILINK® joint	UNILINK® joint
Fastening	Locking mechanism	Locking mechanism	Locking mechanism	Locking mechanism
Load capacity	Drivable	Drivable	Drivable	Drivable
Cover gratings	Freely selectable	Freely selectable	Freely selectable	Freely selectable

<b>Cover gratings</b>			<b>Locking mechanism</b>
Slotted steel / Slotted stainless steel grating	Slotted plastic grating	Slotted cast iron grating	<p>The practical Locking mechanism locks both horizontally and vertically.</p> 
			

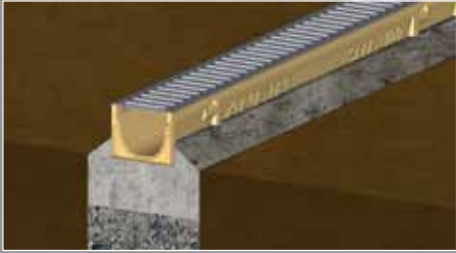
**Installation instructions - ANRIN SELF-100 with slotted steel grating in paving**

	<p>Dig out the trench. Fill in and pre-condense the base course.</p>	
	<p>Form concrete bed, 3 parts sand + 1 part water + 1 part cement, on base course.</p>	
	<p>Position channel string, sump unit and end cap on the concrete bed.</p>	
<p>Install paving. The layer should end 2 to 5 mm higher than the cover grating.</p>		

SELF-100 with slotted top

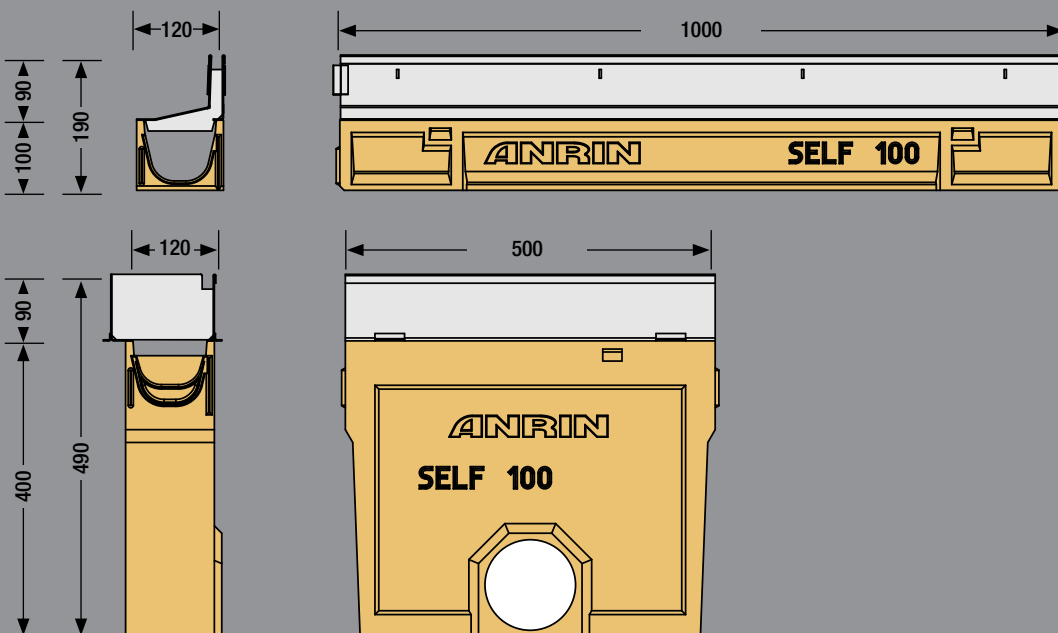

Tip

Always begin the installation of the channel string at the lowest point of the surface with the installation of the sump unit. In doing so, you will achieve the optimal drainage of rainwater to the sewer system.

ANRIN DIRECT CONTACT: **+49 (0) 29 47.97 81-0**

**ANRIN SELF drainage channels with slotted top**

The ANRIN SELF slotted top channels were specially developed for integration of the drainage in high-quality natural stone and paving surfaces (see page 6, fig. 3). The reduction to a discrete inlet slot enables decorative surface designs without compromise.

The steel shaft with smooth interior and exterior duplications enables a gap-free installation of the stones and easy cleaning of the inlets. Innovative design for durable, safe function.

<b>Product specifications</b>	<b>SELF-100 slot</b>	<b>SELF-100 slot sump unit</b>
Material	Resin concrete	Resin concrete
Length	50/100 cm	50 cm
Width	12 cm	12 cm
Height	19 cm	49 cm
Weight	8.3/10.7 kg	19.4 kg
Nominal width	10 cm	10 cm
Joint type	UNILINK® joint	UNILINK® joint
Load capacity	Drivable	Drivable
Slotted top	Steel	Steel

**Installation instructions**



Dig out the trench. Fill in and pre-condense the base course.



Connect pipe connections to the pipeline and align the components evenly. Fill concrete bed.



Fill concrete, 3 parts sand + 1 part water + 1 part cement, into the base of the trench.

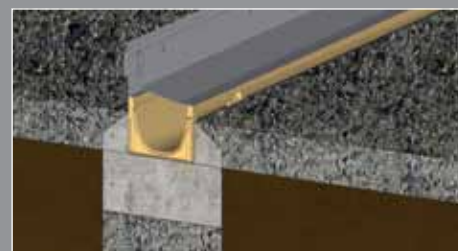

Place slotted tops on the channel bases. Apply gravel base and condense.



Position channel string, sump unit and end cap on the concrete bed.

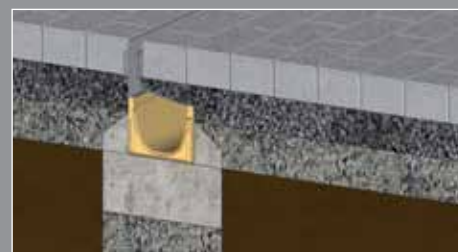

Apply the crushed stone bed and level out. Finish the top layer extending approx. 1 cm over the inlet slot.

## SELF comfort boot scrapers in three practical sizes

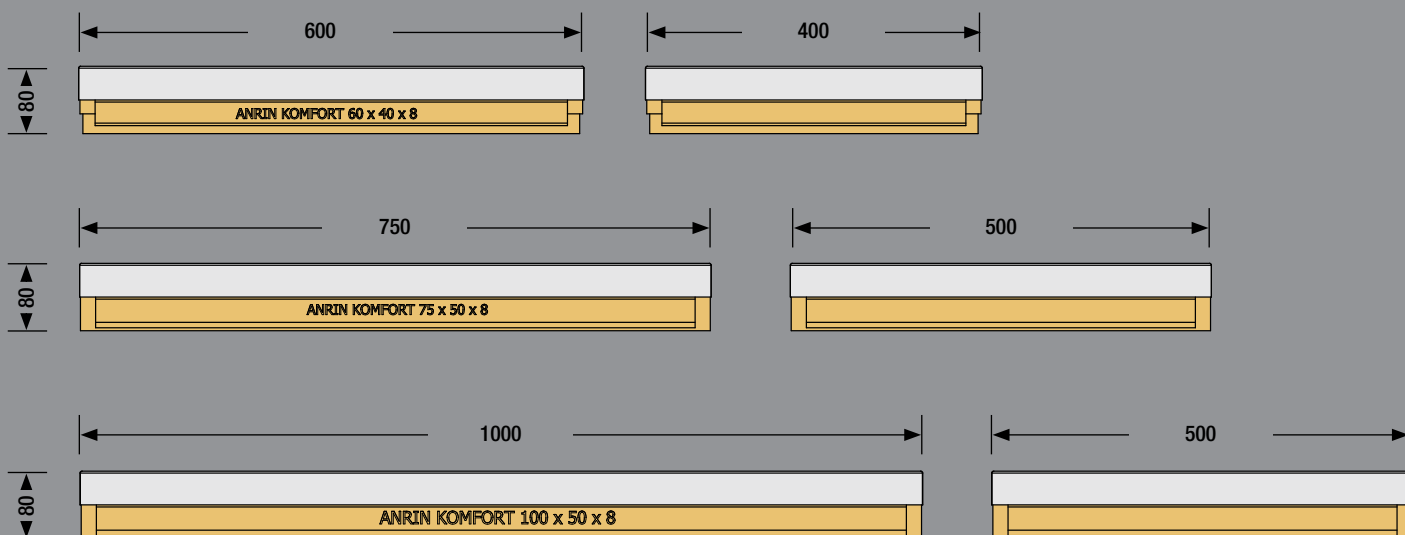

### Tip

With ANRIN SELF products you protect the environment, because our resin concrete is resistant to heavy loads as well as frost and thawing salt. It is also recyclable, suitable for potable water and resistant to a number of chemical substances.

**ANRIN DIRECT CONTACT: +49 (0) 29 47.97 81-0**

## ANRIN SELF comfort boot scrapers

In order to keep entry areas to home clean and dry and for a presentable design, all ANRIN SELF comfort boot scrapers are integrated into the new ground surface. As a result, dirt always remains outside your door, even under

heavy demands. Modern diamond or mesh grating made of galvanised steel and aluminium grating with rubber or needle-felt strips offer the right solution for every use.

<b>Product specifications</b>	<b>small</b>	<b>medium</b>	<b>large</b>
Material	Resin concrete	Resin concrete	Resin concrete
Length	60 cm	75 cm	100 cm
Width	40 cm	50 cm	50 cm
Height	8 cm	8 cm	8 cm
Weight	11.7 kg	19.7 kg	22.9 kg
Drain	DA/OD 110	DA/OD 110	DA/OD 110
Edge type	Steel edge rail, 6 mm, galvanised	Steel edge rail, 6 mm, galvanised	Steel edge rail, 6 mm, galvanised
Cover gratings	Freely selectable	Freely selectable	Freely selectable

### Cover gratings

Diamond grating,  
galvanised

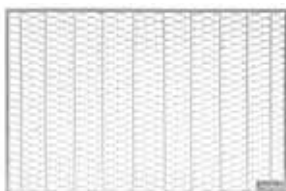

Mesh steel grating  
MW 9 x 30, galvanised

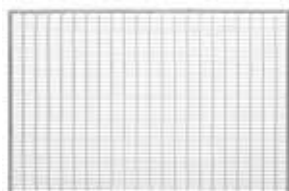

Aluminium grating  
with rubber strips



Aluminium grating  
with needle-felt strips



### Installation instructions



Prepare the surface so that the top edge of the comfort boot scraper ends flush with the top edge of the finished ground surface. Integrate any pipelines to be connected.



Place the scraper box in the ground, on the concrete bed if possible, connect any necessary pipeline and align with the surface.



Fit the cover grating in place and install the surrounding surface structure.

**SELF yard sump  
in various designs**

- ① **Yard sump**  
with slotted cast iron grating
- ② **Yard sump**  
with slotted steel grating
- ③ **Raising piece**  
to increase the installation height,  
with moulded fall pipe connection



①



②



③

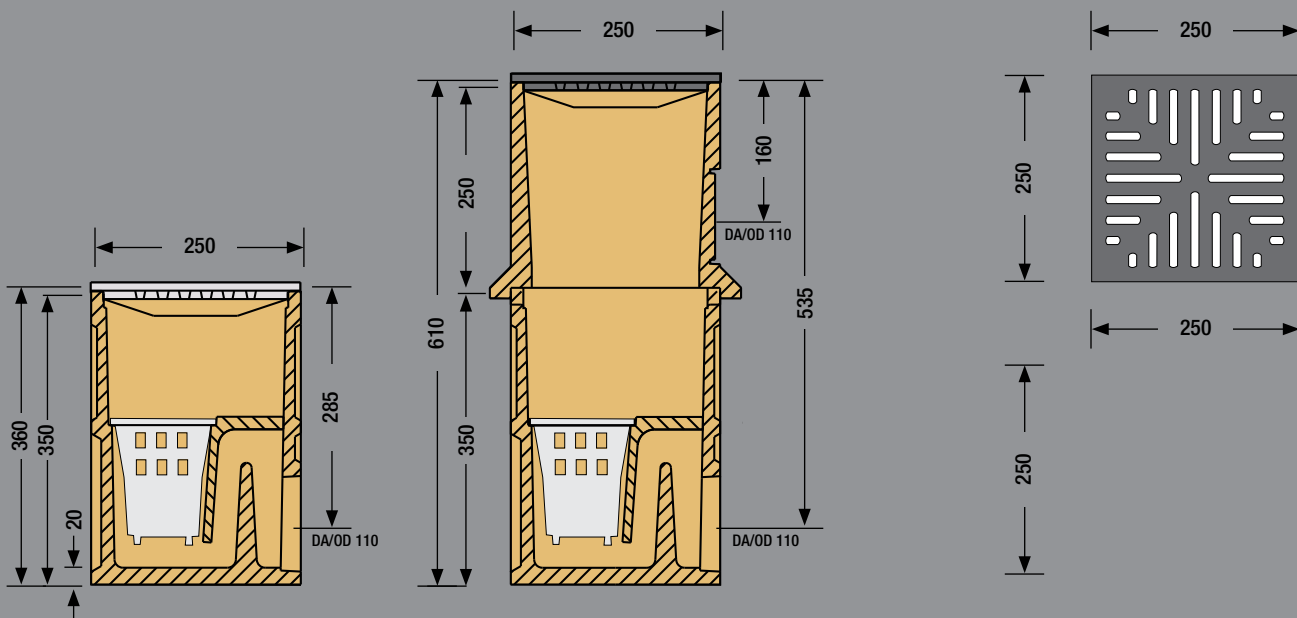

**Tip**

When installing ANRIN SELF products, always make sure that the subsurface has a sufficient load capacity and is well condensed. In doing so, the drainage module in the concrete bed gains the necessary stability to accommodate the forces applied and to dissipate them into the surrounding soil.

**ANRIN DIRECT CONTACT: +49 (0) 29 47.97 81-0**

<b>Product specifications</b>	<b>SELF yard sump with galv. Slotted steel grating</b>	<b>SELF yard sump with slotted cast iron grating</b>	<b>SELF yard sump Raising piece</b>
Material	Resin concrete	Resin concrete	Resin concrete
Length	25 cm	25 cm	25 cm
Width	25 cm	25 cm	25 cm
Height	35 cm	35 cm	25 cm
Weight	15.4 kg	19.8 kg	5.8 kg
Drain	DA/OD 110	DA/OD 110	DA/OD 110
Load capacity	Drivable	Drivable	Drivable
Cover	Slotted steel grating	Slotted cast iron grating	Slotted steel or cast iron grating

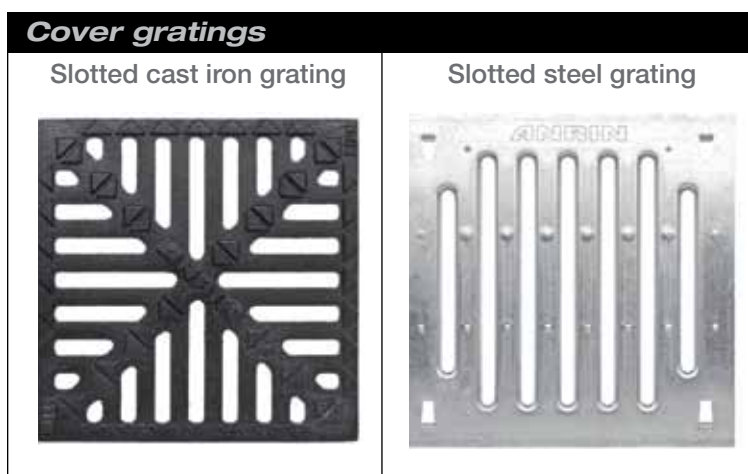

**Installation instructions - ANRIN SELF yard sump in paving**

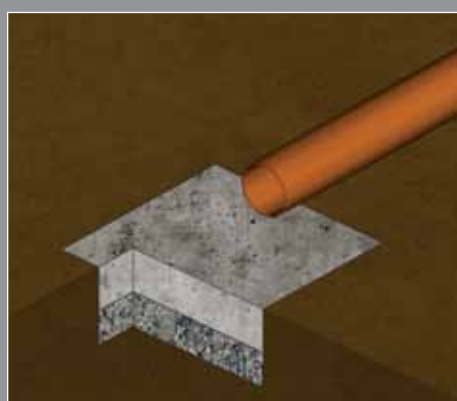

Install the pipeline to the yard sump. Excavate the trench and fill in the concrete bed of 3 parts sand + 1 part water + 1 part cement. With the installation of a yard sump with raising piece, observe the corresponding installation depth.



Fill in the concrete bed and raise it at the sides of the sump unit. Fit the cover grating.

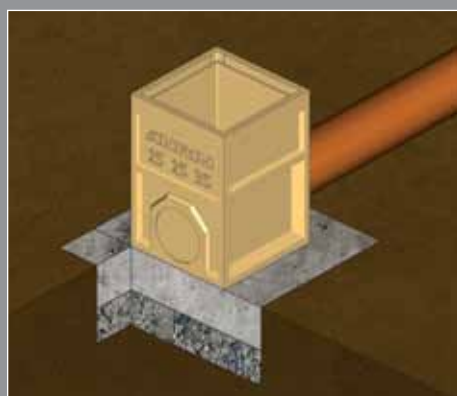

Place the yard sump on the concrete bed and align. Connect the pipeline. With connection of a rainfall pipe, make the perforation on the raising piece and fit the pipe socket. Connect the fall pipe.



Install paving. The layer should end 2 to 5 mm higher than the cover grating.

We invite you  
to discover more.

*Whether you are already planning a specific project or simply want to learn more about the general possibilities: Contact us and put our expertise to the test.*

**ANRIN GmbH**  
**Siemensstraße 1**  
**D-59609 Anröchte**  
**Tel.: +49 (0) 29 47.97 81-0**  
**Fax: +49 (0) 29 47.97 81-50**  
**Email: [info@anrin.com](mailto:info@anrin.com)**  
**Internet: [www.anrin.com](http://www.anrin.com)**

Dealer stamp

