



ADEZZ[®]

WE PRODUCE GARDEN PRODUCTS FOR PROFESSIONALS

2021



Preface

Since 1991, ADEZZ has manufactured planters, outdoor fireplaces and water features in its own manufacturing plant. In order to meet your customers needs best, we offer customised products, RAL-colours and a range of accessories including wheels for practically all our products. We specialise in manufacturing high-quality planters at a very competitive price. These sustainable Dutch quality products will certainly add value to your landscape design.

5 ADEZZ principles:

- Free delivery
- Buy on account, pay after delivery
- 5 year warranty
- Lowest price guarantee
- All standard products in stock, despatched within 1 week

ADEZZ[®]

WE PRODUCE GARDEN PRODUCTS FOR PROFESSIONALS

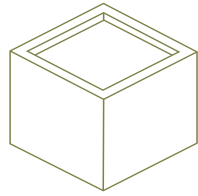

Planters 4-51



Water Features 52-61

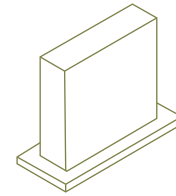

Walls 62-69

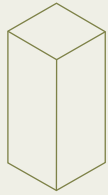

Pedestals 70-71



Letterboxes 72-77

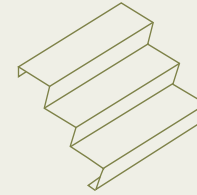

Stairs 78-79

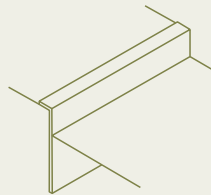

Edging 80-83

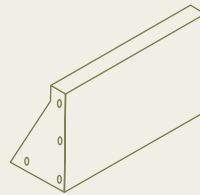

Retaining Walls 84-87

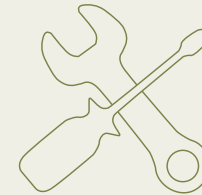

Accessories 88-89



Material
2 mm

Feet
15 mm

Corten Steel

The standard material thickness of our Corten Steel planters is 2mm, although they can also be produced in 3-4 and 5mm. Corten Steel, also known as weather resistant steel, is a very strong steel alloy. As soon as Corten Steel is exposed to the elements it will naturally weather and develop a protective layer of rust. This natural fixed coating of rust provides protection against further corrosion. Characteristics of Corten Steel are the brown-orange rust colour and its longevity. Our Corten Steel products are delivered in an un-rusted state and the weathering process will take about 4-5 months to complete. Corten Steel planters are not recommended to be used in combination with overflow pipes.

As standard, these planters are equipped with 15mm high feet.

5 year warranty



Wheels 450 KG



Corten Varnish



Rust accelerator



Andes (CA)



Andes (CA)

Custom
Made
Possible

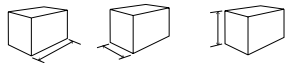

KG

CA1.1	2000	2000	800 mm	181
CA1.2	"	"	600 mm	154
CA1.3	"	"	400 mm	127
CA3.1	1400	1400	800 mm	110
CA3.2	"	"	600 mm	92
CA3.3*	"	"	400 mm	73
CA4.1	1200	1200	800 mm	91
CA4.2*	"	"	600 mm	75
CA4.3*	"	"	400 mm	59
CA5	1000	1000	1000 mm	87
CA5.1*	"	"	800 mm	74
CA5.2*	"	"	600 mm	60
CA5.3*	"	"	400 mm	47
CA6.1*	800	800	800 mm	57
CA6.2*	"	"	600 mm	46
CA6.3*	"	"	400 mm	35
CA7*	700	700	700 mm	41
CA8*	600	600	600 mm	30
CA9*	500	500	500 mm	21
CA9.1*	"	"	800 mm	30
CA9.2	"	"	1000 mm	37
CA10	400	400	400 mm	14
CA10.1	"	"	600 mm	20
CA10.2	"	"	800 mm	24
CA10.3	"	"	1000 mm	29

* Wheels possible

Custom
Made
Possible

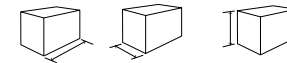

KG

CA20.1	2000	1000	600 mm	100
CA20.2*	"	"	400 mm	80
CA22	2000	500	600 mm	72
CA22.1*	1500	"	"	55
CA22.2*	1200	"	"	46
CA22.3*	900	"	"	38
CA23*	2000	500	500 mm	40
CA23.1*	1500	"	"	35
CA23.2*	1200	"	"	40
CA23.3*	1000	"	"	35
CA24	2000	400	800 mm	80
CA24.1	1500	"	"	63
CA24.2	1200	"	"	52
CA24.3	1000	"	"	46
CA24.4	800	"	"	39
CA25	2000	400	400 mm	49
CA25.1	1500	"	"	38
CA25.2	1200	"	"	31
CA25.3	1000	"	"	26
CA25.4	800	"	"	23
CA26.2	900	300	800 mm	38



Material
2 mm

Feet
90 mm

Corten Steel

The standard material thickness of our Corten Steel planters is 2mm, although they can also be produced in 3-4 and 5mm. Corten Steel, also known as weather resistant steel, is a very strong steel alloy. As soon as Corten Steel is exposed to the elements it will naturally weather and develop a protective layer of rust. This natural fixed coating of rust provides protection against further corrosion. Characteristics of Corten Steel are the brown-orange rust colour and its longevity. Our Corten Steel products are delivered in an un-rusted state and the weathering process will take about 4-5 months to complete. Corten Steel planters are not recommended to be used in combination with overflow pipes.

Model Andes is also available with 90mm feet.

5 year warranty



Corten Varnish



Rust accelerator



Andes (CAP)
feet 90mm



Andes (CAP)
feet 90mm

Custom
Made
Possible

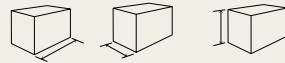

KG

CAP3.1	1400	1400	800 mm	106
CAP4.1	1200	1200	800 mm	88
CAP4.2	"	"	600 mm	74
CAP5.1	1000	1000	800 mm	71
CAP5.2	"	"	600 mm	58
CAP6.1	800	800	800 mm	55
CAP6.2	"	"	600 mm	45
CAP7	700	700	700 mm	43
CAP8	600	600	600 mm	29
CAP22	2000	500	600 mm	66
CAP22.1	1500	"	"	53
CAP22.2	1200	"	"	44
CAP24.2	1200	400	800 mm	53
CAP24.3	1000	"	"	46



Material
2 mm

Feet
15 mm

Corten Steel

The standard material thickness of our Corten Steel planters is 2mm, although they can also be produced in 3-4 and 5mm. Corten Steel, also known as weather resistant steel, is a very strong steel alloy. As soon as Corten Steel is exposed to the elements it will naturally weather and develop a protective layer of rust. This natural fixed coating of rust provides protection against further corrosion. Characteristics of Corten Steel are the brown-orange rust colour and its longevity. Our Corten Steel products are delivered in an un-rusted state and the weathering process will take about 4-5 months to complete. Corten Steel planters are not recommended to be used in combination with overflow pipes.

As standard, these planters are equipped with 15mm high feet.

5 year warranty



Wheels 450 KG



Corten Varnish



Rust accelerator



Atlas (CT)

Custom
Made
Possible



KG

CT1.1	2000	800 mm	135
CT1.2	"	600 mm	117
CT1.3	"	400 mm	99
CT2.1	1500	800 mm	91
CT2.2	"	600 mm	77
CT2.3*	"	400 mm	64
CT4.1*	1200	800 mm	68
CT4.2*	"	600 mm	57
CT4.3*	"	400 mm	47
CT5.1*	1000	800 mm	54
CT5.2*	"	600 mm	51
CT5.3*	"	400 mm	41
CT6.1*	800	800 mm	42
CT6.2*	"	600 mm	34
CT6.3*	"	400 mm	27
CT8	600	600 mm	24
CT8.1	"	800 mm	29
CT8.2	"	1000 mm	35
CT8.3	"	1200 mm	41

* Wheels possible

Cado (CC)

Custom
Made
Possible



KG

CC4	1200	1000 mm	70
CC4.1*	"	800 mm	61
CC4.2*	"	600 mm	51
CC5	1000	1000 mm	56
CC5.1*	"	800 mm	48
CC5.2*	"	600 mm	40
CC6	800	1000 mm	43
CC6.1	"	800 mm	36
CC6.2	"	600 mm	30
CC8.1	600	800 mm	26
CC8.2	"	600 mm	20



Material
3 mm

Feet
90 mm

Corten Steel

The standard material thickness of our Corten Steel planters is 2mm, although they can also be produced in 3-4 and 5mm. Corten Steel, also known as weather resistant steel, is a very strong steel alloy. As soon as Corten Steel is exposed to the elements it will naturally weather and develop a protective layer of rust. This natural fixed coating of rust provides protection against further corrosion. Characteristics of Corten Steel are the brown-orange rust colour and its longevity. Our Corten Steel products are delivered in an un-rusted state and the weathering process will take about 4-5 months to complete. Corten Steel planters are not recommended to be used in combination with overflow pipes.

Model Atlas and Cado are also available with 90mm feet.

5 year warranty



Corten Varnish



Rust accelerator

New



Atlas (CTP)
feet 90mm



Cado (CCP)
feet 90mm

Custom
Made
Possible



KG

CTP1.1	2000	800 mm	210
CTP2.1	1500	"	141
CTP4.1	1200	"	107
CTP5.1	1000	"	84

Custom
Made
Possible



KG

CCP1.1	2000	800 mm	190
CCP2.1	1500	"	126
CCP4.1	1200	"	92
CCP5.1	1000	"	73



Material
2 mm

Corten Steel

The standard material thickness of our Corten Steel planters is 2mm, although they can also be produced in 3-4 and 5mm. Corten Steel, also known as weather resistant steel, is a very strong steel alloy. As soon as Corten Steel is exposed to the elements it will naturally weather and develop a protective layer of rust. This natural fixed coating of rust provides protection against further corrosion. Characteristics of Corten Steel are the brown-orange rust colour and its longevity. Our Corten Steel products are delivered in an un-rusted state and the weathering process will take about 4-5 months to complete.

5 year warranty



Corten Varnish



Rust accelerator

New

Corten steel



Andes without bottom (CAW)

Atlas without bottom (CTW)

Custom Made Possible

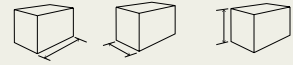

				KG
CAW1.1	2000	2000	800 mm	125
CAW1.2	"	"	600 mm	96
CAW1.3	"	"	400 mm	69
CAW3.1	1400	1400	800 mm	86
CAW3.2	"	"	600 mm	66
CAW3.3	"	"	400 mm	48
CAW4.1	1200	1200	800 mm	73
CAW4.2	"	"	600 mm	57
CAW4.3	"	"	400 mm	41
CAW5.1	1000	1000	800 mm	61
CAW5.2	"	"	600 mm	48
CAW5.3	"	"	400 mm	35
CAW6.1	800	800	800 mm	50
CAW6.2	"	"	600 mm	39
CAW6.3	"	"	400 mm	27
CAW20.1	2000	1000	600 mm	72
CAW20.2	"	"	400 mm	52

Custom Made Possible



			KG
CTW1.2	2000	600 mm	72
CTW1.3	"	400 mm	53
CTW2.2	1500	600 mm	54
CTW2.3	"	400 mm	39
CTW4.2	1200	600 mm	43
CTW4.3	"	400 mm	31
CTW5.2	1000	600 mm	36
CTW5.3	"	400 mm	26



Material
3 mm

Feet
15 mm

Corten Steel

The standard material thickness of our Corten Steel planters is 2mm, although they can also be produced in 3-4 and 5mm. Corten Steel, also known as weather resistant steel, is a very strong steel alloy. As soon as Corten Steel is exposed to the elements it will naturally weather and develop a protective layer of rust. This natural fixed coating of rust provides protection against further corrosion. Characteristics of Corten Steel are the brown-orange rust colour and its longevity. Our Corten Steel products are delivered in an un-rusted state and the weathering process will take about 4-5 months to complete. Corten Steel planters are not recommended to be used in combination with overflow pipes.

As standard, these planters are equipped with 15mm high feet.

5 year warranty



Corten Varnish



Rust accelerator



Ellipse (CEL)



Ellipse (CEL)

Custom
Made
Possible

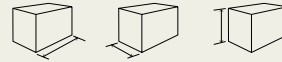

KG

CEL1	2800	1600	600 mm	205
CEL2	"	"	400 mm	165
CEL3	2000	1200	600 mm	135
CEL4	"	"	400 mm	106
CEL5	1200	800	600 mm	71
CEL6	"	"	400 mm	54

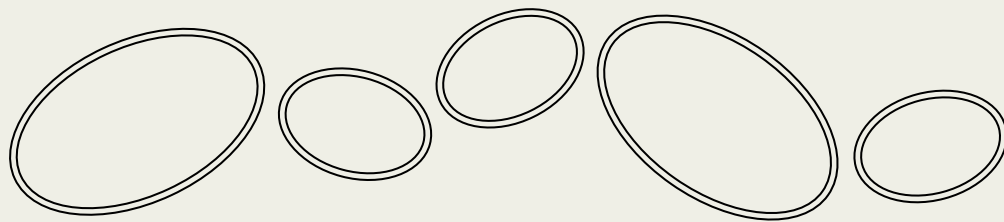



Material
4 mm

Feet
90 mm

Galvanised Steel

Hot-dip galvanisation is a production process of galvanising. This process involves providing the metal with a layer of zinc by immersing the product in a bath of molten zinc of about 460° Celsius. The usually dull grey material protects the metal from corrosion caused by weather influences.

5 year warranty



Overflow pipe



Vadim (VS)

Custom
Made
Possible

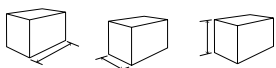
**KG**

VS3.1	1400	1400	800 mm	213
VS4.1	1200	1200	"	176
VS5.1	1000	1000	"	138
VS6.1	800	800	"	108
VS7	700	700	700 mm	84
VS8	600	600	600 mm	57



New

Vaza (VSA)

Custom
Made
Possible

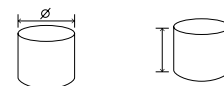
**KG**

VSA1	1000/700	1000 mm	102
VSA2	800/600	800 mm	69

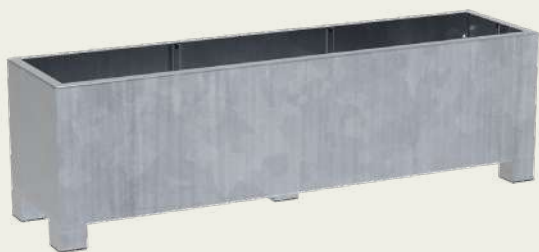

Vadim (VS)

VS22	2000	500	600 mm	130
VS22.1	1500	"	"	105
VS22.2	1200	"	"	88



Material
3 mm

Feet
15 mm

Aluminum

These planters are made of 3mm thick aluminum as standard, although they can also be produced in 4-5mm. Aluminum is light, strong, durable and resistant to corrosion. The top edge of all planters is reversed twice, which gives them a strong and timeless appearance. All Aluminum planters are equipped with 15mm high feet, so the planter is raised slightly off the ground. Once constructed the planters are powder coated with a strong adhesive primer and finished with a coloured coating.

Standard colours are **RAL 7021 | 7035 | 9016**. Almost all other RAL colours are possible (beware of start-up costs)

5 year warranty



Cleaner and protector



Descaling



Wheels 450 KG



Overflow pipe



Florida (AF)



Florida (AF)

Custom Made Possible

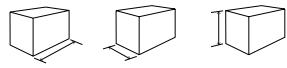

KG

AF1.2	2000	2000	600 mm	82
AF1.3	"	"	400 mm	68
AF3.1	1400	1400	800 mm	60
AF3.2	"	"	600 mm	50
AF3.3*	"	"	400 mm	39
AF4.1	1200	1200	800 mm	48
AF4.2*	"	"	600 mm	39
AF4.3*	"	"	400 mm	30
AF5	1000	1000	1000 mm	46
AF5.1*	"	"	800 mm	39
AF5.2*	"	"	600 mm	31
AF5.3*	"	"	400 mm	23
AF6.1*	800	800	800 mm	30
AF6.2*	"	"	600 mm	24
AF6.3*	"	"	400 mm	18
AF7*	700	700	700 mm	21
AF8*	600	600	600 mm	16
AF9*	500	500	500 mm	11
AF9.1*	"	"	800 mm	16
AF9.2	"	"	1000 mm	19
AF10	400	400	400 mm	7
AF10.1	"	"	600 mm	10
AF10.2	"	"	800 mm	12
AF10.3	"	"	1000 mm	15

* Wheels possible

Custom Made Possible

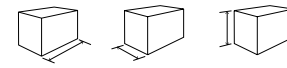

KG

AF20.1	2000	1000	600 mm	51
AF20.2*	"	"	400 mm	41
AF22	2000	500	600 mm	37
AF22.1*	1500	"	"	28
AF22.2*	1200	"	"	24
AF22.3*	900	"	"	20
AF23*	2000	500	500 mm	32
AF23.1*	1500	"	"	25
AF23.2*	1200	"	"	21
AF23.3*	1000	"	"	18
AF24	2000	400	800 mm	41
AF24.1	1500	"	"	32
AF24.2	1200	"	"	27
AF24.3	1000	"	"	24
AF24.4	800	"	"	20
AF25	2000	400	400 mm	25
AF25.1	1500	"	"	19
AF25.2	1200	"	"	16
AF25.3	1000	"	"	14
AF26.2	900	300	800 mm	20



Material
3 mm

Feet
90 mm

Aluminum

These planters are made of 3mm thick aluminum as standard, although they can also be produced in 4-5mm. Aluminum is light, strong, durable and resistant to corrosion. The top edge of all planters is reversed twice, which gives them a strong and timeless appearance. Once constructed the planters are powder coated with a strong adhesive primer and finished with a coloured coating.

Standard colours are **RAL 7021 | 7035 | 9016**. Almost all other RAL colours are possible (beware of start-up costs)

5 year warranty



Cleaner and protector



Descaling



Overflow pipe



Florida (AFP)
Feet 90mm



Florida (AFP)
Feet 90mm

Custom
Made
Possible

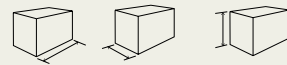

KG

AFP3.1	1400	1400	800 mm	55
AFP4.1	1200	1200	800 mm	45
AFP4.2	"	"	600 mm	39
AFP5.1	1000	1000	800 mm	37
AFP5.2	"	"	600 mm	31
AFP6.1	800	800	800 mm	28
AFP6.2	"	"	600 mm	23
AFP7	700	700	700 mm	22
AFP8	600	600	600 mm	15
AFP22	2000	500	600 mm	35
AFP22.1	1500	"	"	27
AFP22.2	1200	"	"	23
AFP24.2	1200	400	800 mm	27
AFP24.3	1000	"	"	24



Material
3 mm

Feet
15 mm

Aluminum

These planters are made of 3mm thick aluminum as standard, although they can also be produced in 4-5mm. Aluminum is light, strong, durable and resistant to corrosion. The top edge of all planters is reversed twice, which gives them a strong and timeless appearance. All Aluminum planters are equipped with 15mm high feet, so the planter is raised slightly off the ground. Once constructed the planters are powder coated with a strong adhesive primer and finished with a coloured coating.

Standard colours are **RAL 7021 | 7035 | 9016**. Almost all other RAL colours are possible (beware of start-up costs)

5 year warranty



Cleaner and protector



Descaling



Wheels 450 KG



Overflow pipe



Sydney (AM)

Cairo (AC)

Custom
Made
Possible



KG

AM1.2	2000	600 mm	62
AM1.3	"	400 mm	53
AM2.1	1500	800 mm	48
AM2.2	"	600 mm	41
AM2.3*	"	400 mm	34
AM4.1*	1200	800 mm	35
AM4.2*	"	600 mm	29
AM4.3*	"	400 mm	24
AM5.1*	1000	800 mm	28
AM5.2*	"	600 mm	23
AM5.3*	"	400 mm	19
AM6.1*	800	800 mm	22
AM6.2*	"	600 mm	17
AM6.3*	"	400 mm	14
AM8	600	600 mm	12
AM8.1	"	800 mm	15
AM8.2	"	1000 mm	18
AM8.3	"	1200 mm	21

* Wheels possible

Custom
Made
Possible

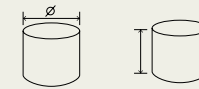

KG

AC4	1200	1000 mm	45
AC4.1*	"	800 mm	39
AC4.2*	"	600 mm	33
AC5	1000	1000 mm	36
AC5.1*	"	800 mm	31
AC5.2*	"	600 mm	26
AC6	800	1000 mm	27
AC6.1	"	800 mm	23
AC6.2	"	600 mm	19
AC8.1	600	800 mm	16
AC8.2	"	600 mm	13



Material
3 mm

Feet
90 mm

Aluminum

These planters are made of 3mm thick aluminum as standard, although they can also be produced in 4-5mm. Aluminum is light, strong, durable and resistant to corrosion. The top edge of all planters is reversed twice, which gives them a strong and timeless appearance. Once constructed the planters are powder coated with a strong adhesive primer and finished with a coloured coating.

Standard colours are **RAL 7021 | 7035 | 9016**. Almost all other RAL colours are possible (beware of start-up costs)

5 year warranty



Cleaner and protector



Descaling



Overflow pipe

New

Aluminum



Sydney (AMP)
feet 90mm

Custom
Made
Possible



KG

	Ø	Height	KG
AMP1.1	2000	800 mm	97
AMP2.1	1500	"	65
AMP4.1	1200	"	49
AMP5.1	1000	"	39

Cairo (ACP)
feet 90mm

Custom
Made
Possible

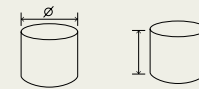

KG

	Ø	Height	KG
ACP1.1	2000	800 mm	87
ACP2.1	1500	"	58
ACP4.1	1200	"	42
ACP5.1	1000	"	34



Material
3 mm

Feet
15 mm

Aluminum

These planters are made of 3mm thick aluminum as standard, although they can also be produced in 4-5mm. Aluminum is light, strong, durable and resistant to corrosion. The top edge of all planters is reversed twice, which gives them a strong and timeless appearance. All Aluminum planters are equipped with 15mm high feet, so the planter is raised slightly off the ground. Once constructed the planters are powder coated with a strong adhesive primer and finished with a coloured coating.

Standard colours are **RAL 7021 | 7035 | 9016**. Almost all other RAL colours are possible (beware of start-up costs)

5 year warranty



Cleaner and protector



Descaling



Overflow pipe



Ellipse (AEL)



Ellipse (AEL)

Custom
Made
Possible

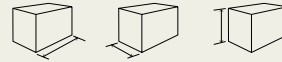

KG

AEL1	2800	1600	600 mm	91
AEL2	"	"	400 mm	75
AEL3	2000	1200	600 mm	59
AEL4	"	"	400 mm	47
AEL5	1200	800	600 mm	32
AEL6	"	"	400 mm	25

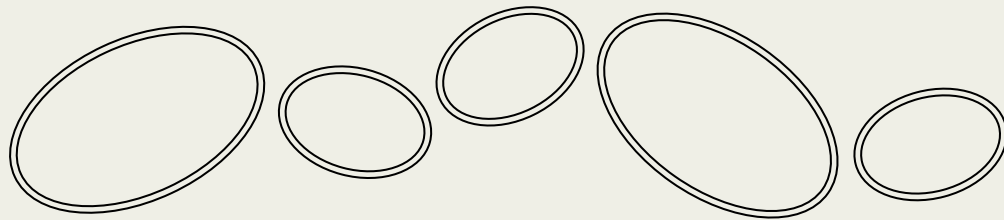



Aluminum
4 mm

Corten
3 mm

Plant frames

By GROENR

We have developed these Plant Frames to accentuate your border, protect your plants and realise clean lines in your garden. Because of the open structure of the frame it does not dominate and gives peace to the defined flowerbed. Lush planting is given a framework and will be better reflected. Available in Corten steel (3mm) and Aluminum (4mm).

Standard colours for Aluminum are **RAL 7021 | 7035 | 9016**. Almost all other RAL colours are possible (beware of start-up costs)

5 year warranty



Cleaner and protector



Descaling



Corten Varnish



Rust accelerator



Plant Frame (APF8)



Plant Frame (CPF8)

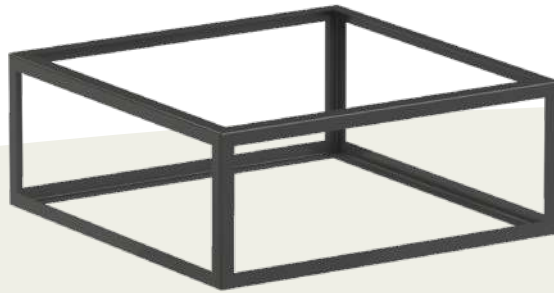

Plant Frame (APF4)



Plant Frame (CPF4)

Custom Made Possible

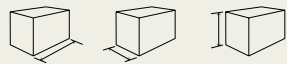

KG

APF1	2000	2000	400 mm	14
APF2	1400	1400	"	10
APF3	1200	1200	"	8
APF4	1000	1000	"	7
APF5	800	800	"	6
APF6	600	600	"	5
APF7	1200	"	"	7
APF8	1000	"	"	6

Custom Made Possible

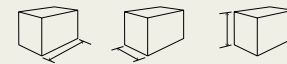

KG

CPF1	2000	2000	400 mm	30
CPF2	1400	1400	"	22
CPF3	1200	1200	"	19
CPF4	1000	1000	"	16
CPF5	800	800	"	13
CPF6	600	600	"	10
CPF7	1200	"	"	15
CPF8	1000	"	"	13



Material
22 mm

Feet
Valencia
90 mm

Hardwood

These high quality planters are made from tropical hardwood that is legally harvested. This ensures that they are environmentally sustainable and they provide a warm and natural appearance. We only use hardwood with durability class 2. Due to the high durability of the wood no further treatment is required. If the planters are not treated they will gradually age, which has no influence on the quality of the planters. They are constructed using stainless steel fasteners, the inside is wrapped with EPDM and the bottom with anti-root fabric.

5 year warranty



Valencia (HR)



Valencia (HR)

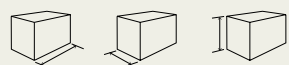

KG

HR4	1200	1200	950 mm	109
HR4.2	"	"	600 mm	71
HR5	1000	1000	950 mm	87
HR5.2	"	"	600 mm	56
HR6	800	800	800 mm	52
HR6.1	"	"	600 mm	39
HR7	700	700	700 mm	37
HR8	600	600	600 mm	29
HR22	2000	500	600 mm	65
HR22.1	1500	"	"	48
HR22.2	1200	"	"	38
HR24.2	1200	400	800 mm	43
HR24.3	1000	"	"	37



Material
22 mm

Feet
Sevilla
20 mm

Hardwood

These high quality planters are made from tropical hardwood that is legally harvested. This ensures that they are environmentally sustainable and they provide a warm and natural appearance. We only use hardwood with durability class 2. Due to the high durability of the wood no further treatment is required. If the planters are not treated they will gradually age, which has no influence on the quality of the planters. They are constructed using stainless steel fasteners, the inside is wrapped with EPDM and the bottom with anti-root fabric. We offer our Sevilla model in bespoke dimensions.

5 year warranty



Wheels 450 KG



Sevilla (HS)



Sevilla Taps (HO)

Custom
Made
Possible

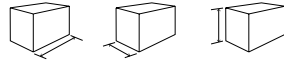

KG

HS3	1400	1400	713 mm	115
HS4.1	1200	1200	713 mm	96
HS4.2	"	"	574 mm	84
HS4.3	"	"	435 mm	60
HS5.1*	1000	1000	713 mm	80
HS5.2*	"	"	574 mm	70
HS5.3	"	"	435 mm	49
HS6.1*	800	800	713 mm	62
HS6.2*	"	"	574 mm	54
HS6.3	"	"	435 mm	37
HS8*	600	600	574 mm	43
HS10	400	400	435 mm	20
HS22*	2000	500	574 mm	83
HS22.1*	1500	"	"	67
HS22.2*	1200	"	"	59
HS24	2000	400	713 mm	90
HS24.1	1500	"	"	73
HS24.2	1200	"	"	64
HS24.3	1000	"	"	57
HS25	2000	400	435 mm	54
HS25.1	1500	"	"	43
HS25.2	1200	"	"	38
HS25.3	1000	"	"	33

* Wheels possible

Custom
Made
Possible

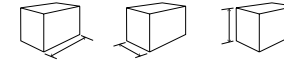

KG

HO5*	700	700	989 mm	57
HO6*	600	600	850 mm	42
HO7*	550	550	712 mm	33
HO8*	500	500	574 mm	25



Material
22 mm

Feet
Mallaga
20 mm

Hardwood

These high quality planters are made from tropical hardwood that is legally harvested. This ensures that they are environmentally sustainable and they provide a warm and natural appearance. We only use hardwood with durability class 2. Due to the high durability of the wood no further treatment is required. If the planters are not treated they will gradually age, which has no influence on the quality of the planters. They are constructed using stainless steel fasteners, the inside is wrapped with EPDM and the bottom with anti-root fabric.

5 year warranty



Wheels 450 KG

New

Hardwood



Malaga Rhombus (HRS)



Malaga Rhombus (HRS)

Custom
Made
Possible

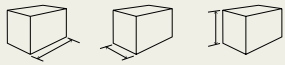

KG

HRS4.1*	1200	1200	746 mm	93
HRS5.1*	1000	1000	"	74
HRS6*	800	800	"	56
HRS8*	600	600	608 mm	34
HRS22*	2000	500	608 mm	75
HRS22.1*	1500	"	"	64
HRS22.2*	1200	"	"	49

* Wheels possible



Material
3 mm

Standard
Colour
RAL 7021

Fibreglass

Our fibreglass planters are manufactured in high-quality reinforced fibreglass, with additional reinforcement in the corners. The standard colour used is black/grey **RAL 7021**. Also available in RAL colours: **7006 | 7016 | 7035 | 9005 | 9010 | 9016** (surcharge 10%). The quality of all our fibreglass planters is enhanced by the colouring, which runs through the entire material. The upper edge has been reversed twice, which gives this planter a splendid timeless appearance. We recommend that the planter should be cleaned at least twice a year. Please note that some cleaners may damage or affect the material. The best product for cleaning and maintaining fibreglass is the "Cleaner and protector set" that we offer on the accessories page. Do not clean with steel wool, sand paper, solvents or any other abrasive materials, cleaning with a pressure washer can also cause damage.

5 year warranty



Cleaner and protector



Overflow pipe



Wheels 450 KG

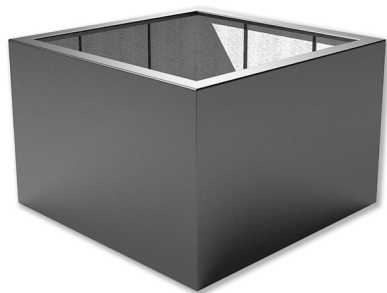

Buxus (PB)

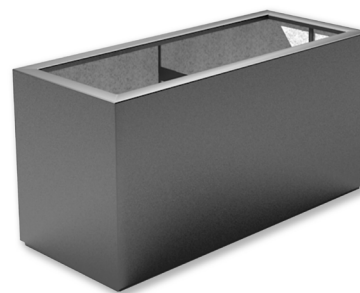

Buxus (PB)

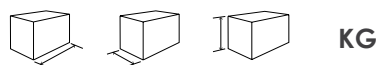

				KG
PB1.2	2000	2000	600 mm	49
PB1.3	"	"	400 mm	40
PB2.2	1600	1600	600 mm	49
PB3.2	1400	1400	600 mm	30
PB3.3	"	"	400 mm	24
PB4	1200	1200	1000 mm	34
PB4.1	"	"	800 mm	29
PB4.2	"	"	600 mm	24
PB4.3	"	"	400 mm	19
PB5	1000	1000	1000 mm	27
PB5.1	"	"	800 mm	23
PB5.2	"	"	600 mm	19
PB5.3	"	"	400 mm	15
PB6.1*	800	800	800 mm	18
PB6.2*	"	"	600 mm	14
PB6.3*	"	"	400 mm	11
PB7*	700	700	700 mm	14
PB8*	600	600	600 mm	10
PB9*	500	500	500 mm	7
PB9.1*	"	"	800 mm	10
PB9.2*	"	"	1000 mm	12
PB10	400	400	400 mm	4
PB10.1	"	"	600 mm	6
PB10.2	"	"	800 mm	8
PB10.3	"	"	1000 mm	9
PB10.4	"	"	1200 mm	11

* Wheels possible

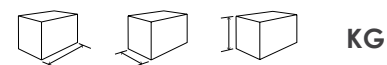

				KG
PB20.1	2000	1000	600 mm	31
PB20.2	"	"	400 mm	25
PB21	2300	500	400 mm	19
PB22*	2000	500	600 mm	22
PB22.1*	1500	"	"	17
PB22.2*	1200	"	"	14
PB22.3*	900	"	"	11
PB23*	2000	500	500 mm	19
PB23.1*	1500	"	"	15
PB23.2*	1200	"	"	13
PB23.3*	1000	"	"	11
PB24	2000	400	800 mm	25
PB24.1	1500	"	"	19
PB24.2	1200	"	"	16
PB24.3	1000	"	"	14
PB24.4	800	"	"	12
PB25	2000	400	400 mm	15
PB25.1	1500	"	"	12
PB25.2	1200	"	"	10
PB25.3	1000	"	"	8
PB25.4	800	"	"	7
PB25.5	600	"	"	5
PB28	1500	250	800 mm	18
PB28.2	900	"	"	11



Material
3 mm

Standard
Colour
RAL 7021

Fibreglass

Our fibreglass planters are manufactured in high-quality reinforced fibreglass, with additional reinforcement in the corners. The standard colour used is black/grey **RAL 7021**. Also available in RAL colours: **7006 | 7016 | 7035 | 9005 | 9010 | 9016** (surcharge 10%). The quality of all our fibreglass planters is enhanced by the colouring, which runs through the entire material. The upper edge has been reversed twice, which gives this planter a splendid timeless appearance. We recommend that the planter should be cleaned at least twice a year. Please note that some cleaners may damage or affect the material. The best product for cleaning and maintaining fibreglass is the "Cleaner and protector set" that we offer on the accessories page. Do not clean with steel wool, sand paper, solvents or any other abrasive materials, cleaning with a pressure washer can also cause damage.

5 year warranty



Cleaner and protector



Overflow pipe

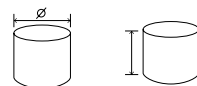

KG

Acer (PE)



PE1.1	1500	800 mm	20
PE1	1200	800 mm	13
PE2	950	700 mm	9
PE3	890	1000 mm	11
PE4	630	520 mm	5
PE5	550	760 mm	5

Canna (PC)



PC1	500	590 mm	4
PC2	"	900 mm	6
PC3	720	840 mm	8
PC4	800	1000 mm	11
PC5	1000	950 mm	12
PC6	700	1120 mm	11

Ceder (PD)



PD1	2000	400 mm	17
PD2	1530	340 mm	12
PD3	1200	400 mm	9

Bellis (PJ)



PJ1	1500	600 mm	25
PJ2	1200	"	19
PJ3	1000	"	15
PJ4	800	"	11

Malva (PM)



PM1	1200	200 mm	7
PM2	2000	400 mm	18



Material
3 mm

Standard
Colour
RAL 7021

ORGAN Fibreglass

Fantastic beautiful organic, natural forms that stand out both solitary or as in a group. Planters that are no longer subordinate to the planting but are an important part of the entire composition.

The top edge is reversed twice and follows the contours of the planters.

Standard produced in black/grey **RAL 7021**, (high gloss **RAL 9016**). Other available RAL colours: **7006 | 7016 | 7035 | 9005 | 9010 | 9016** (10% surcharge).

These planters are made of high quality Fibreglass which is coloured throughout the entire material.

We advise to clean and maintain the planters twice a year. Therefore we have a professional cleaning and care product available: "Cleaner and protector set".

5 year warranty



Cleaner and protector



Overflow pipe



Organ (PO/POH)

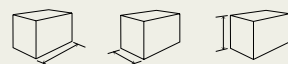

KG

PO1	1610	1335	600 mm	26
POH1*	"	"	"	26

* High gloss

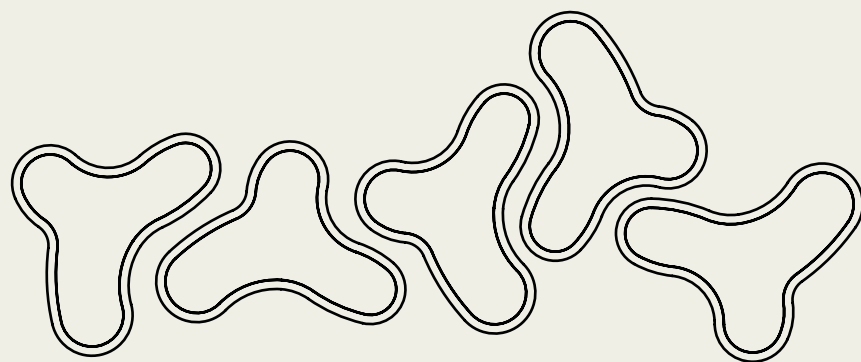



Material
3 mm

Standard
Colour
RAL 7021

SHAPE Fibreglass

Fantastic beautiful organic, natural forms that stand out both solitary or as in a group. Planters that are no longer subordinate to the planting but are an important part of the entire composition.

The top edge is reversed twice and follows the contours of the planters.

Standard produced in black/grey **RAL 7021**, (high gloss **RAL 9016**). Other available RAL colours: **7006** | **7016** | **7035** | **9005** | **9010** | **9016** (10% surcharge).

These planters are made of high quality Fibreglass which is coloured throughout the entire material.

We advise to clean and maintain the planters twice a year. Therefore we have a professional cleaning and care product available: "Cleaner and protector set".

5 year warranty



Cleaner and protector



Overflow pipe



Shape (PS/PSH)

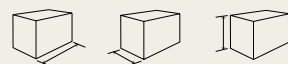

KG

PS1	1300	1260	600 mm	21
PSH1*	"	"	"	21

* High gloss

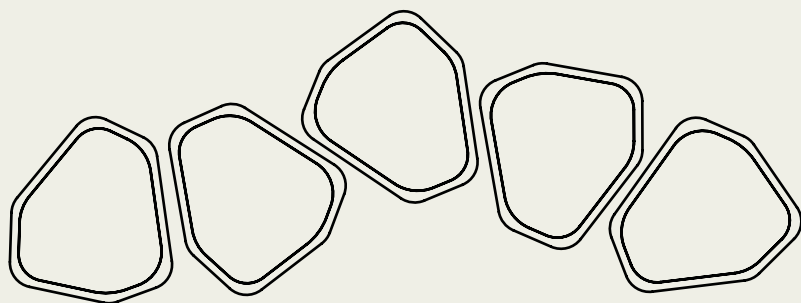



Material
3 mm

Standard
Colour
RAL 7021

ELLIPSE Fibreglass

A beautiful sleek fibreglass planter in an oval shape. This oval shape is applicable everywhere and has a surprisingly beautiful appearance from every angle. The upper edge is reversed twice and accentuates this beautiful sleek shape.
Standard produced in black/grey **RAL 7021**, (high gloss **RAL 9016**). Other available RAL colours: **7006 | 7016 | 7035 | 9005 | 9010 | 9016** (10% surcharge).
These planters are made from high-quality fibreglass, which runs through the entire material.
We advise to clean the planters at least twice a year. Therefore we have a professional cleaning and care product available: "Cleaner and protector set".

5 year warranty



Cleaner and protector



Overflow pipe



Ellipse (PEL1)



Ellipse (PEL2)

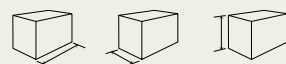

KG

PEL1	2000	1200	600 mm	34
PELH1*	"	"	"	34
PEL2	1150	800	"	20
PELH2*	"	"	"	20

* High gloss

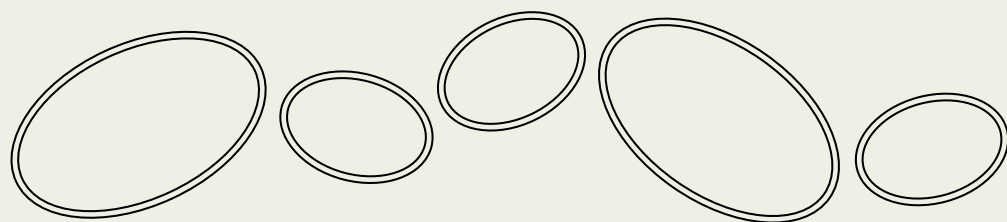



Material
3 mm

Standard
Colour
RAL 9016

Fibreglass glossy

Our fibreglass planters are manufactured in high-quality reinforced fibreglass, with additional reinforcement in the corners. The standard colour used **RAL 9016**. Also available in **RAL colours: 7021 | 7006 | 7016 | 7035 | 9005 | 9010** (surcharge 10%). The quality of all our fibreglass planters is enhanced by the colouring, which runs through the entire material. The upper edge has been reversed twice, which gives this planter a splendid timeless appearance. We recommend that the planter is cleaned at least twice a year. Please note that some cleaners may damage or affect the material. The best product for cleaning and maintaining fibreglass is the "Cleaner and protector set" that we offer on the accessories page. Do not clean with steel wool, sand paper, solvents or any other abrasive materials, cleaning with a pressure washer can also cause damage.

5 year warranty



Cleaner and protector



Overflow pipe





Wheels 450 KG





Buxus (PBH)



Canna (PCH)

				KG
PBH5.1	1000	1000	800 mm	23
PBH5.2	"	"	600 mm	19
PBH6.1*	800	800	800 mm	18
PBH6.2*	"	"	600 mm	16
PBH7*	700	700	700 mm	14
PBH8*	600	600	600 mm	10
PBH9*	500	500	500 mm	7
PBH10	400	400	400 mm	4
PBH10.1	"	"	600 mm	6
PBH10.2	"	"	800 mm	8
PBH10.3	"	"	1000 mm	9
PBH10.4	"	"	1200 mm	11
PBH22.1*	1500	500	600 mm	17
PBH22.2*	1200	"	"	14
PBH25.3	1000	400	400 mm	8
PBH28.2	900	250	800 mm	11

* Wheels possible

			KG
PCH1	500	590 mm	4
PCH2	"	900 mm	6
PCH3	720	840 mm	8
PCH4	800	1000 mm	11
PCH6	700	1120 mm	11



Standard
Colour
RAL 7021

Brett: gardening at height

We have developed this product for the easy growing and harvesting of flowers, herbs and plants. A fibreglass planter with a height of 200mm is placed on a solid base made from 12 mm solid round steel, powder coated in **DB703**. The 3mm thick Fibreglass planter is available in the standard **RAL 7021**. Also available in **RAL colours: 7006 | 7016 | 7035 | 9005 | 9010 | 9016** (surcharge 10%).

5 year warranty



Cleaner and protector



Overflow pipe



New



Brett (PR2)



Brett (PR4)



				KG
PR2	1500	500	200/910 mm	35
PR4	1000	"	"	29



Screen (SR2)



Screen (SR3)

				KG
SR2	2040	500	1350	40
SR3	"	"	2100	50



Material
23 mm

Colour
RAL 7035

Polymer Concrete

Polymer Concrete is a moulded stone composite, which is ideal for use in public spaces. The material is highly compressed, making it extremely strong. The composite is made out of natural minerals mixed with binding agents, which are becoming increasingly recyclable. The planters are not submitted to wear and tear. They are 100% watertight and are therefore extremely frost resistant. The closed structure of the material means that it does not hold dirt and will naturally clean from rainwater.

Advantages:

- Very high compressive strength and bending-resistance, many times higher than fibre reinforced concrete
- 100% watertight and therefore frost-proof
- Durable material, not submitted to wear and tear
- Natural mineral such as quartz, basalt and granite mixed with synthetic resin
- Compact structure, which prevents dirt from attaching; a proper downpour will clean the product
- 5 year warranty



Banco (BT)

				KG
BT5.1	1000	1000	800 mm	250
BT6	800	800	"	172
BT6.1	"	"	600 mm	139
BT8	600	600	"	103



Besso (BS)

			KG
BS1	2000	400 mm	269
BS2	1500	"	125
BS4	1800	450 mm	237
BS5	2350	600 mm	500



Picasso (BP)

BP1	1000	600 mm	120
BP2	600	900 mm	70



Barro (BR)

BR1	1200	900 mm	231
BR2	1500	1200 mm	408



Bodil (BD)
with 60mm feet

BD1	1800	400 mm	378
BD2	2350	"	624



Corten Steel
3 mm

Water Features

Our water features are sure to create an oasis in your garden. The variety of designs and shapes is enormous. Round, square and rectangular shapes are possible. Many of the models can be ordered with a waterfall or fountain and these can also include LED lighting.

All our ponds are provided with an high-strength wear resistant polyurea coating (2mm thick) on the inside as standard.

Each pond has 2 connections as standard, with 1 inch inner tread. In addition, each pond has a fixed overflow pipe. On our website you can download the installation manual and technical drawings.

Ponds and pond walls are made to order therefore never in stock. Delivery time for standard sizes is 8 weeks, delivery time for bespoke sizes on request.

5 year warranty



Corten Steel pond
(VC)



Wall placed on pond
(VCM1...)



Wall freestanding
(VCM2...)
(VCM3...)

Custom
Made
Possible

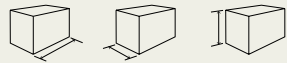

				KG
VC1	6000	1000	600 mm	440
VC1.1	"	"	400 mm	377
VC2	5000	1000	600 mm	380
VC2.1	"	"	400 mm	317
VC3	4000	1000	600 mm	311
VC3.1	"	"	400 mm	259
VC4	3000	2000	600 mm	358
VC4.1	"	"	400 mm	306
VC5	3000	1500	600 mm	298
VC5.1	"	"	400 mm	252
VC6	3000	1000	600 mm	243
VC6.1	"	"	400 mm	201
VC7	3000	800	600 mm	221
VC7.1	"	"	400 mm	181
VC8	2500	1200	600 mm	228
VC8.1	"	"	400 mm	190
VC9	2000	800	600 mm	156
VC9.1	"	"	400 mm	128
VC10	1500	800	600 mm	124
VC10.1	"	"	400 mm	101
VC11	1200	800	600 mm	106
VC11.1	"	"	400 mm	86

Custom
Made
Possible



				KG
VCM1.1	3000	250	600 mm	98
VCM1.2	2500	"	"	83
VCM1.3	2000	"	"	67
VCM1.4	1500	"	"	51
VCM1.5	1200	"	"	42
VCM1.6	1000	"	"	36

Exclusive waterfall and pump

VCM2.1	3000	250	1200 mm	168
VCM2.2	2500	"	"	142
VCM2.3	2000	"	"	116
VCM3.1	1500	250	1000 mm	74
VCM3.2	1200	"	"	61
VCM3.3	1000	"	"	52

Exclusive waterfall and pump



Aluminum
4 mm

Water Features

Our water features are sure to create an oasis in your garden. The variety of designs and shapes is enormous. Round, square and rectangular shapes are possible. Many of the models can be ordered with a waterfall or fountain and these can also include LED lighting.

Standard colours Aluminum **RAL 7021, 7035, 9016**. Almost all other standard RAL colours are possible (beware of start-up costs).

All our ponds are provided with an high-strength wear resistant polyurea coating (2mm thick) as standard.

Each pond has 2 connections as standard, with 1 inch inner tread. In addition, each pond has a fixed overflow pipe. On our website you can download the installation manual and technical drawings.

Ponds and pond walls are made to order therefore never in stock. Delivery time for standard sizes is 8 weeks, delivery time for bespoke sizes on request.

5 year warranty



Corten Steel pond
(VA)



Wall placed on pond
(VM1...)



Wall freestanding
(VM2...)
(VM3...)



Custom
Made
Possible

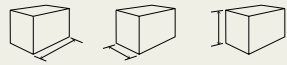

KG

VA1	6000	1000	600 mm	201
VA1.1	"	"	400 mm	168
VA2	5000	1000	600 mm	172
VA2.1	"	"	400 mm	143
VA3	4000	1000	600 mm	140
VA3.1	"	"	400 mm	117
VA4	3000	2000	600 mm	162
VA4.1	"	"	400 mm	138
VA5	3000	1500	600 mm	143
VA5.1	"	"	400 mm	115
VA6	3000	1000	600 mm	109
VA6.1	"	"	400 mm	91
VA7	3000	800	600 mm	99
VA7.1	"	"	400 mm	81
VA8	2500	1200	600 mm	104
VA8.1	"	"	400 mm	87
VA9	2000	800	600 mm	71
VA9.1	"	"	400 mm	58
VA10	1500	800	600 mm	57
VA10.1	"	"	400 mm	46
VA11	1200	800	600 mm	48
VA11.1	"	"	400 mm	39

Custom
Made
Possible

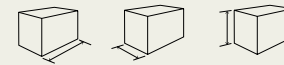

KG

VM1.1	3000	250	600 mm	58
VM1.2	2500	"	"	49
VM1.3	2000	"	"	38
VM1.4	1500	"	"	30
VM1.5	1200	"	"	25
VM1.6	1000	"	"	21

Exclusive waterfall and pump

VM2.1	3000	250	1200 mm	76
VM2.2	2500	"	"	64
VM2.3	2000	"	"	53
VM3.1	1500	250	1000 mm	53
VM3.2	1200	"	"	36
VM3.3	1000	"	"	31

Exclusive waterfall and pump



Corten Steel
3 mm

Aluminum
3 mm

Aluminum
RAL7021

Water Features

			KG
WNG1	600	140 mm	8
WNG2	800	210 mm	16
WNG3	1000	"	23
WNG4	1200	"	33
WNG5 *	1500	310 mm	75
WNS1	600	140 mm	8
WNS2	800	210 mm	16
WNS3	1000	"	23
WNS4	1200	"	33
WNS5 *	1500	310 mm	75
WNS6 **	2000	"	120

* Material 4mm ** Material 5mm



Water bowl (WNG)
Coating DB703





Water bowl (WNS)
Corten



Water table Aluminium (AB1-4)

Water table Corten (CB1-4)

Custom Made Possible (6m max)

				KG
AB1 6 fountains	6000	1000	400 mm	186
AB2 5 fountains	5000	"	"	155
AB3 4 fountains	4000	"	"	127
AB4 3 fountains	3000	"	"	97
AB5 2 fountains	2000	800	"	49



CB1 6 fountains	6000	1000	400 mm	444
CB2 5 fountains	5000	"	"	373
CB3 4 fountains	4000	"	"	304
CB4 3 fountains	3000	"	"	232
CB5 2 fountains	2000	800	"	137

Water table standard with LED light and pump



Water table Aluminium (ABR)

Water table Corten (CBR)

			KG
ABR1	1450	750 mm	61
ABR2	1200	"	46
ABR3	1000	"	36
ABR4	1450	400 mm	48
ABR5	1200	"	35
ABR6	1000	"	26

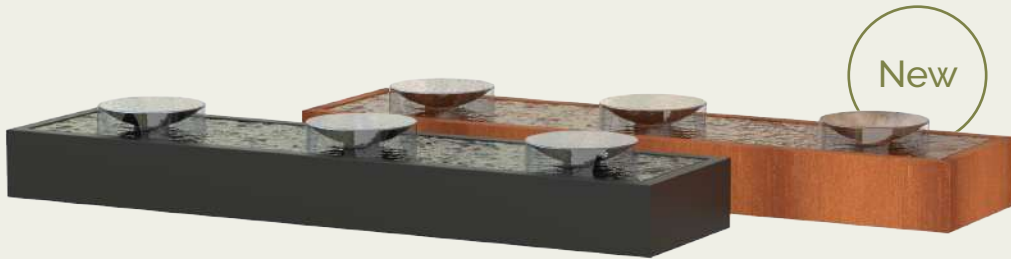

CBR1	1450	750 mm	165
CBR2	1200	"	126
CBR3	1000	"	98
CBR4	1450	400 mm	125
CBR5	1200	"	93
CBR6	1000	"	71

Water table standard with LED light and pump



Water table with bowls Aluminium (ABS)

Water table with bowls Corten (CBS)



				KG
ABS2 4 water bowls	5000	1000	520 mm	188
ABS3 3 water bowls	4000	"	"	147
CBS2 4 water bowls	5000	1000	520 mm	423
CBS3 3 water bowls	4000	"	"	343

Water table standard with LED light, pump and water bowls



Water table Aluminium (AB11-13)

Water table Corten (CB11-13)

				KG
AB11	1200	1200	400 mm	42
AB12	1000	1000	"	30
AB13	800	800	"	23
CB11	1200	1200	400 mm	115
CB12	1000	1000	"	87
CB13	800	800	"	62

Water table standard with LED light and pump





Corten Steel
3 mm

Aluminum
3 mm

Water blocks

Unique Corten Steel or Aluminum water ornaments with a material thickness of 3 mm. We can produce almost any standard RAL-colour in Aluminum. The water bubbles up from a stainless steel nozzle with LED lighting in the middle of the top plate. The water then runs evenly along the sides of the block into the underground reservoir and is subsequently pumped up again. Comes with pump, LED lighting and nozzle.

5 year warranty



Water block



KG

AWB1	Alu Coating 7021	700 (1100)	700 (1100)	700 (1080) mm	79
AWB4	Alu 7021 3 nozzles	3000 (3400)	"	"	209
CWB1	Corten	700 (1100)	700 (1100)	700 (1080) mm	173
CWB4	Corten 3 nozzles	3000 (3400)	"	"	464

Water block standard with LED light and pump

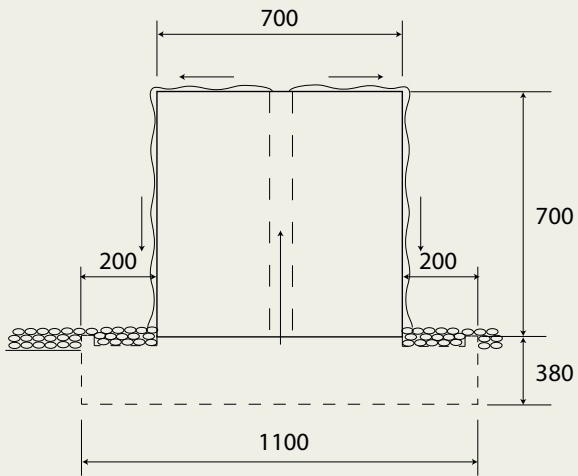



Accessories Water Features

All our accessories meet the highest standards and are a perfect fit to our products.



OASE PONTEC pump



OASE LED light for waterfall



OASE LED for watertable



Waterfall 3 pipes



Waterfall 600 mm



Waterfall 1500 mm

		Material	Corresponding pump
VB1	Waterfall 600 (outflow 50mm)	Stainless steel	VP3
VB2	Waterfall 600 (outflow 150mm)	"	VP3
VB3	Waterfall 1500 (outflow 50mm)	"	VP5
VB4	Waterfall 1500 (outflow 150mm)	"	VP5
VB5	Waterfall 930 (outflow 3 pipes 200mm)	"	VP3
VB6	LED 600mm		
VP1	Eco Pump 1500(25W) with hose		
VP3	Eco Pump 5000(60W) with hose		
VP4	Eco Pump 11000(80W) with hose		
VP5	Pump Aqua Forte P-25000 with hose		



Walls Fibreglass

These are extremely rigid walls, which can be mounted to any surface using the mounting strip along the length of the base.

Benefits fibreglass walls:

- Cheaper than comparable walls
- Light in weight due to hollow construction
- Very rigid fiber reinforced material
- Easy to maintain
- The standard colour used is white **RAL 9016**. Also available in **RAL colours: 7021, 7035, 9010**

The cleaning solution must be carefully chosen to ensure that it does not scratch the wall. Do not clean with steel wool, sand paper, solvents or any other abrasive materials, cleaning with a pressure washer can also cause damage. We have put together a special cleaning product: "Cleaner + Protector set".

5 year warranty

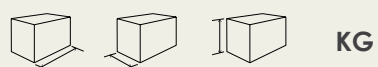
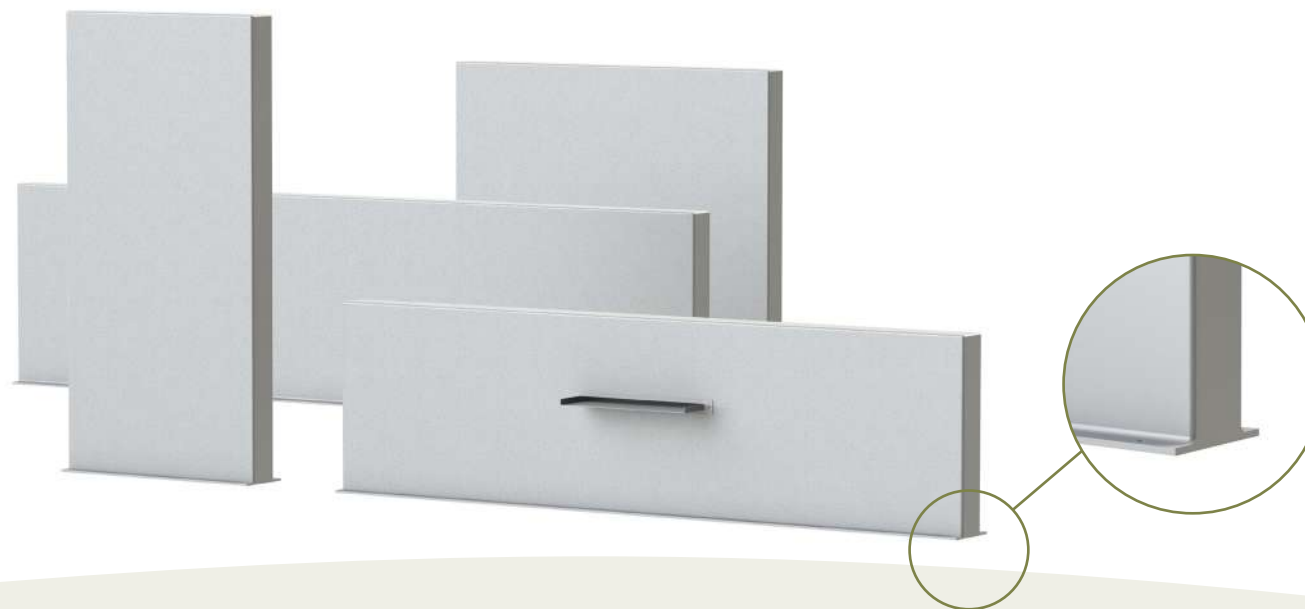

				KG
PW1	4000	150	2000 mm	98
PW1.1	"	"	1500 mm	75
PW1.2	"	"	1000 mm	53
PW1.3	"	"	800 mm	43
PW2	3000	150	2000 mm	75
PW2.1	"	"	1500 mm	57
PW2.2	"	"	1000 mm	40
PW2.3	"	"	800 mm	33
PW3	2000	150	2000 mm	51
PW3.1	"	"	1500 mm	39
PW3.2	"	"	1000 mm	27
PW3.3	"	"	800 mm	23
PW5	1000	150	2000 mm	27
PW5.1	"	"	1500 mm	21
PW5.2	"	"	1000 mm	15
PW5.3	"	"	800 mm	12



Aluminum
3 mm

Walls Aluminum

Aluminum walls are the perfect way to create a haven in your garden. It is possible to produce almost any size and they are available in almost all standard RAL colours. These are very rigid walls with a mounting strip on the base. To clean this product, we recommend "Cleaner and protector set", specially developed for cleaning of Aluminum, which is available from us.

Standard colours are **RAL 7021, 7035, 9016**. Almost all other standard RAL colours are possible (beware of start-up costs).

5 year warranty



Cleaner and protector

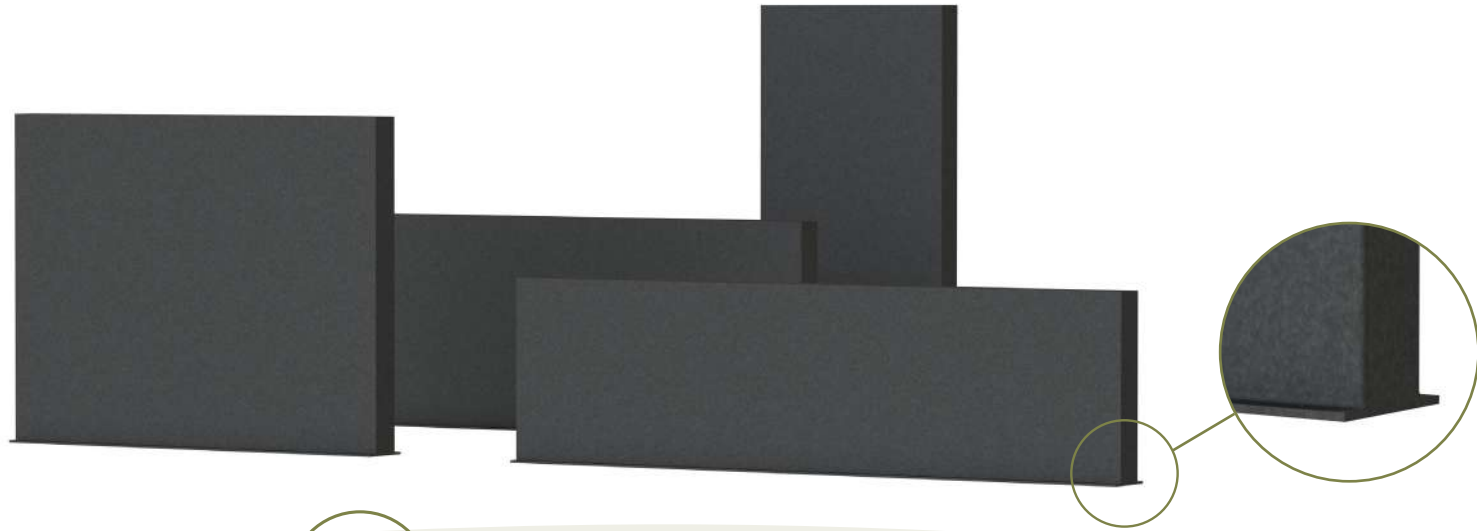

Custom
Made
Possible
(6m max)

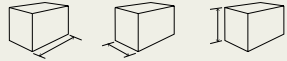

KG

AW1	4000	150	2000 mm	141
AW1.1	"	"	1350 mm	103
AW1.2	"	"	1000 mm	75
AW1.3	"	"	800 mm	63
AW1.4	"	"	600 mm	50
AW2	3000	150	2000 mm	107
AW2.1	"	"	1350 mm	75
AW2.2	"	"	1000 mm	57
AW2.3	"	"	800 mm	47
AW2.4	"	"	600 mm	38
AW3	2000	150	2000 mm	73
AW3.1	"	"	1350 mm	51
AW3.2	"	"	1000 mm	39
AW3.3	"	"	800 mm	32
AW3.4	"	"	600 mm	26
AW4	1500	150	2000 mm	58
AW4.1	"	"	1350 mm	40
AW4.2	"	"	1000 mm	31
AW4.3	"	"	800 mm	25
AW4.4	"	"	600 mm	20
AW5	1000	150	2000 mm	39
AW5.1	"	"	1350 mm	27
AW5.2	"	"	1000 mm	21
AW5.3	"	"	800 mm	17
AW5.4	"	"	600 mm	14





Corten Steel
2 mm

Walls Corten Steel

The Corten steel walls are extremely rigid, which can be mounted to any surface using the mounting strip along the length of the base. The advantage of our Corten Steel Walls is that they have a hollow construction, so you can simply add lighting etc.

Benefits Corten Steel walls:

- Cheaper than comparable walls
- Very rigid material
- Easy to create surprising views
- Natural appearance
- Custom made possible
- 5 year warranty



Rust accelerator



Custom
Made
Possible
(6m max)

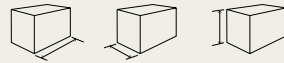

KG

CW1	4000	150	2000 mm	282
CW1.1	"	"	1350 mm	205
CW1.2	"	"	1000 mm	149
CW1.3	"	"	800 mm	122
CW1.4	"	"	600 mm	96
CW2	3000	150	2000 mm	214
CW2.1	"	"	1350 mm	149
CW2.2	"	"	1000 mm	113
CW2.3	"	"	800 mm	93
CW2.4	"	"	600 mm	73
CW3	2000	150	2000 mm	146
CW3.1	"	"	1350 mm	101
CW3.2	"	"	1000 mm	77
CW3.3	"	"	800 mm	64
CW3.4	"	"	600 mm	50
CW4	1500	150	2000 mm	146
CW4.1	"	"	1350 mm	101
CW4.2	"	"	1000 mm	77
CW4.3	"	"	800 mm	64
CW4.4	"	"	600 mm	38
CW5	1000	150	2000 mm	78
CW5.1	"	"	1350 mm	54
CW5.2	"	"	1000 mm	41
CW5.3	"	"	800 mm	34
CW5.4	"	"	600 mm	26





Corten Steel
2 mm

Aluminum
3 mm

DECORATIVE LASERCUT PANELS

IN CORTEN STEEL AND POWDER COATED ALUMINUM

ADEZZ® decorative panels in Corten steel and Aluminum.

Transparent panels help to give structure to your garden and can be used to create private intimate areas in the most exposed environments.

ADEZZ® decorative panels have a simple unique link system and are characterised by:

- High stability due to folded edges
- Materials; Corten steel or Aluminum with a scratch-resistant colour coating
- Various fixing methods; on the floor / between columns, posts and walls
- Easy installation through good access to the fixing elements
- T-profiles available for placing in concrete and invisible connection of the panels.
- Rounded edge with tight frame on all sides which gives the panels stability
- Timeless design and applicable in any garden
- 5 year warranty

Dimensions of the panels: Width 1100mm and Height 1800mm.

We have all designs in stock. The panels can be quickly and easily applied in your garden design.

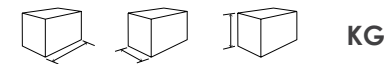

	106	60	2700 mm	KG
CPP1	106	60	2700 mm	20
APP1	"	"	"	16



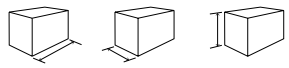

KG

APB1	1100	50	1800 mm	16
APB2	600	"	"	9
APN1	1100	50	1800 mm	16
APN2	"	"	"	"
APN3	"	"	"	"
APN4	"	"	"	"
APN5	"	"	"	"
APN6	"	"	"	"
APN7	"	"	"	"
APN8	"	"	"	"
APN9	"	"	"	"
APN10	"	"	"	"
APN11	"	"	"	"
APA2.1	1100	50	1800 mm	16
APA2.2	"	"	"	"
APA2.3	"	"	"	"
APA2.4	"	"	"	"
APA3	1100	50	1800 mm	16
APA4	"	"	"	"
APA5	"	"	"	"
APA6	"	"	"	"
APA7	"	"	"	"
APA8	1100	50	1800 mm	16
APA8.1	"	"	"	"
APA8.2	"	"	"	"

Visit our website for all designs: www.adezz.com

New



CPB1

CPN1

CPA3

CPN6

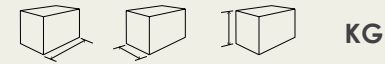

KG

CPB1	1100	50	1800 mm	38
CPB2	600	"	"	23
CPN1	1100	50	1800 mm	38
CPN2	"	"	"	"
CPN3	"	"	"	"
CPN4	"	"	"	"
CPN5	"	"	"	"
CPN6	"	"	"	"
CPN7	"	"	"	"
CPN8	"	"	"	"
CPN9	"	"	"	"
CPN10	"	"	"	"
CPN11	"	"	"	"
CPA2.1	1100	50	1800 mm	38
CPA2.2	"	"	"	"
CPA2.3	"	"	"	"
CPA2.4	"	"	"	"
CPA3	1100	50	1800 mm	38
CPA4	"	"	"	"
CPA5	"	"	"	"
CPA6	"	"	"	"
CPA7	"	"	"	"
CPA8	1100	50	1800 mm	38
CPA8.1	"	"	"	"
CPA8.2	"	"	"	"

New

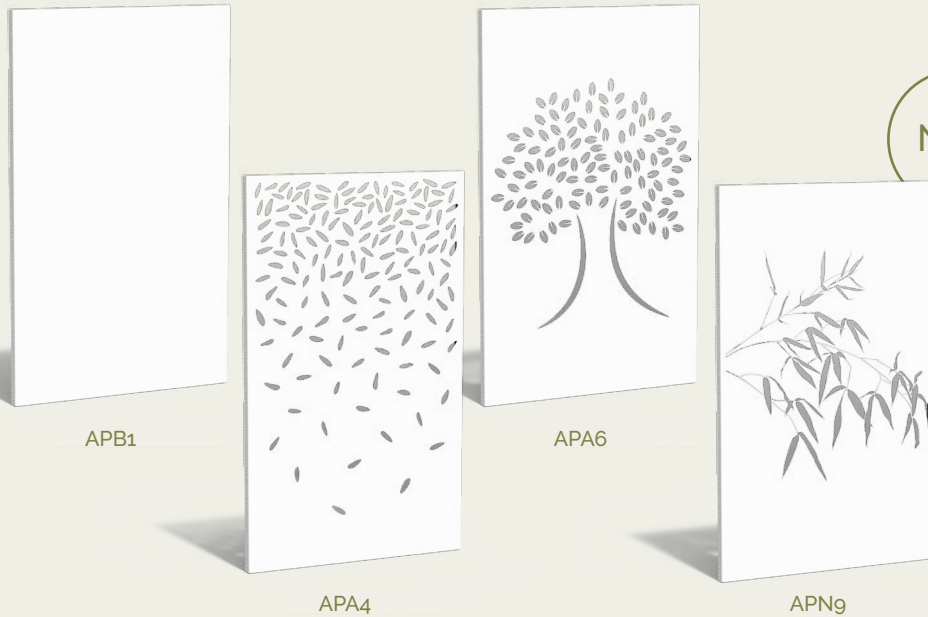

APB1

APA6

APA4

APN9

Visit our website for all designs: www.adezz.com



Corten Steel
2 mm

Aluminum
3 mm

Pedestals

We make Solid and U-shaped pedestals in different sizes, allowing you to display objects upto 150kg. The openwork pedestal (U-block) can also be used as a wood storage unit.

5 year warranty



Rust accelerator



Cleaner and protector



Corten Varnish



Pedestals (CK)



Pedestals U block (CKU)

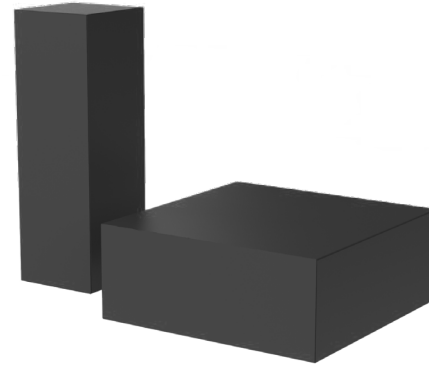

Aluminum pedestals (AS)

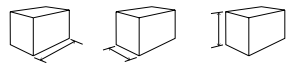

KG

CK1	500	500	1200 mm	42
CK2	"	"	1000 mm	36
CK3	"	"	800 mm	29
CK4	"	"	600 mm	23
CK5	400	400	1200 mm	33
CK6	"	"	1000 mm	28
CK7	"	"	800 mm	23
CK8	"	"	600 mm	18
CK9	"	"	400 mm	13
CK10	300	300	1000 mm	21
CK11	"	"	800 mm	17
CK12	"	"	600 mm	13
CK13	"	"	400 mm	9
CK20	1200	1200	400 mm	54
CK21	1000	1000	"	42
CK22	800	800	"	31
CK23	600	600	"	21
CK30	2000	400	400 mm	44
CK31	1500	"	"	34
CK32	1000	"	"	24
CKU1	500	500	1200 mm	52
CKU2	"	"	1000 mm	44
CKU3	"	"	800 mm	37
CKU4	"	"	600 mm	29
CKU5	400	400	1200 mm	41
CKU6	"	"	1000 mm	35
CKU7	"	"	800 mm	29
CKU8	"	"	600 mm	23
CKU9	"	"	400 mm	17

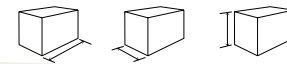

KG

AS1	500	500	1200 mm	23
AS2	"	"	1000 mm	19
AS3	"	"	800 mm	16
AS4	"	"	600 mm	12
AS5	400	400	1200 mm	18
AS6	"	"	1000 mm	15
AS7	"	"	800 mm	12
AS8	"	"	600 mm	10
AS9	"	"	400 mm	7
AS10	300	300	1000 mm	11
AS11	"	"	800 mm	9
AS12	"	"	600 mm	7
AS13	"	"	400 mm	5
AS20	1200	1200	400 mm	29
AS21	1000	1000	"	22
AS22	800	800	"	16
AS23	600	600	"	11
AS30	2000	400	400 mm	23
AS31	1500	"	"	18
AS32	1000	"	"	13





Letterboxes

We have three timeless mailbox models in our collection, which are available in either Corten Steel or powder coated Aluminum. The Aluminum powder coated version can be supplied in almost any RAL colour and it is possible to order numbers and letters for any of the models. All letterboxes have a lockable door and are supplied with two keys.

Standard colours Aluminum: **RAL 7021, 7035, 9016**. Almost all other standard RAL colours are possible (beware of start-up costs).

5 year warranty

Available in Corten Steel and stainless steel:

0, 1, 2, 3, 4, 5, 6, 7, 8, 9, a, b, c, d





Ivar



Hacon



Flyn



KG

Ivar IVC1	Corten	350	350	1200 mm	34
Ivar IVA1	Aluminum	"	"	"	18
Hacon HAC1	Corten	350	350	1200 mm	34
Hacon HAA1	Aluminum	"	"	"	18
Flyn LFC1	Corten	350	350	1200 mm	41
Flyn LFA1	Aluminum	"	"	"	18





CASE package box

Online shopping has become indispensable. You either stay home or burden your neighbours with receiving your package. Package box CASE solves this problem. Your order can be delivered to your address in your absence in an elegant way. By applying a valve the package will fall in the package box and can only be retrieved by you. The finish is stylish and compact. It is also a mail box and your house number can be applied easily. Available in Corten Steel and Aluminum.

The CASE package box is equipped with a Soft Close mechanism for increased ease of use.

5 year warranty

Standard colours Aluminum: **RAL 7021, 7035, 9016**. Almost all other standard RAL colours are possible (start-up costs apply here).



Case

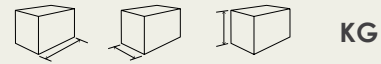

	500	400	1200mm	KG
Case PCC1 Corten	"	"	"	58
Case PCA1 Aluminum	"	"	"	30

Maximum package size 400x300x250 mm

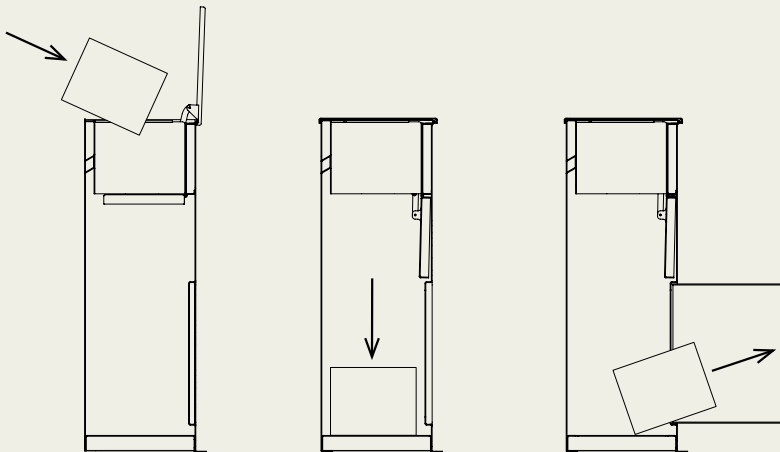

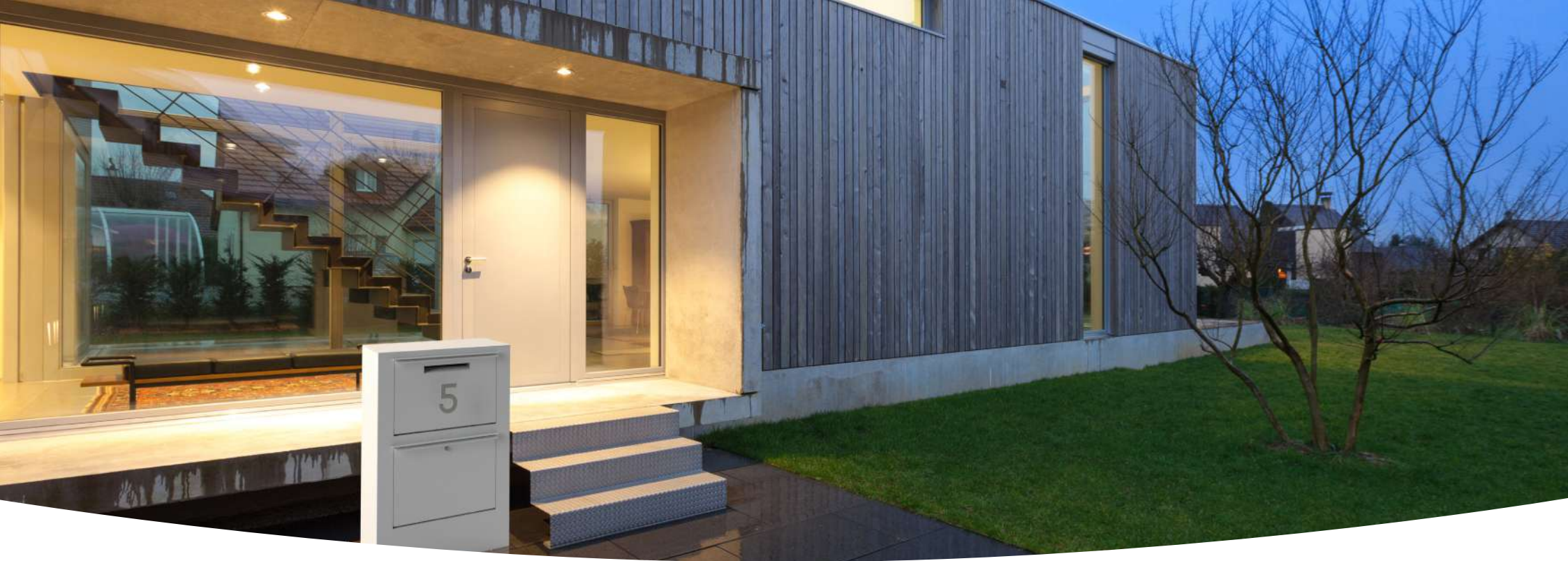

PACA package box

Online shopping has become indispensable. You either stay home or burden your neighbours with receiving your package. Package box PACA solves this problem. Your order can be delivered to your address in your absence in an elegant way. By applying a valve the package will fall in the package box and can only be retrieved by you. The finish is stylish and compact. It is also a mail box and your house number can be applied easily. Available in Corten Steel and Aluminum.

The PACA package box is equipped with a Soft Open mechanism for increased ease of use.

5 year warranty

Standard colours Aluminum: **RAL 7021, 7035, 9016**. Almost all other standard RAL colours are possible (start-up costs apply here).



Paca

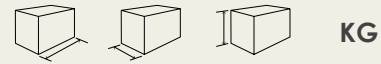

KG

Paca PPS1	Corten	870	300	1250mm	110
Paca PPA1	Aluminum	"	"	"	41

Maximum package size 600x400x240 mm

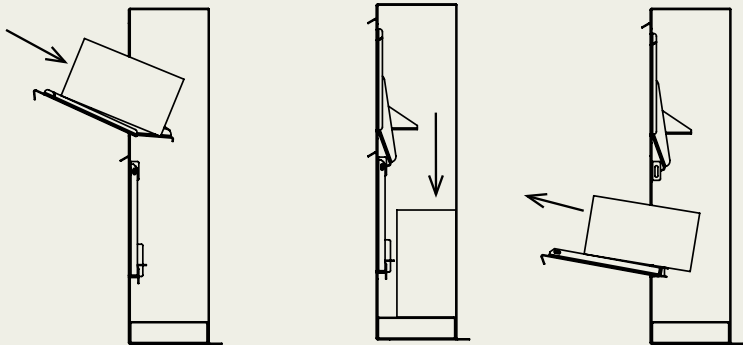



Corten Steel
4 mm

Aluminum
4 mm

Stairs

We offer ready made garden staircases in Corten Steel for height differences in your garden. The width of these stairs may range from 1000mm to 3000mm.

The steps have a standard height of 170 mm and we produce a staircase with a maximum of 10 or 17 steps.

Also available in Aluminum (4mm).

Standard colour Aluminum: **RAL 9005**. Almost all other standard RAL colours are possible (start-up costs apply here).

Stairs are made to order therefore never in stock. Delivery time is 3 weeks.

5 year warranty

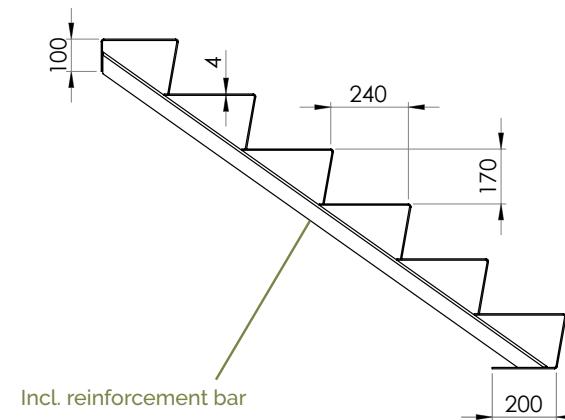



Corten steel stairs (CST)



Aluminum stairs (AST)

Custom
Made
Possible

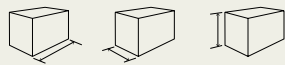

KG

CST2.1 2 steps	1000	480	340 mm	41
extra step (max 17)	"	240	170 mm	18
CST2.2 2 steps	1250	480	340 mm	50
extra step (max 17)	"	240	170 mm	21
CST2.3 2 steps	1500	480	340 mm	62
extra step (max 10)	"	240	170 mm	27
CST2.4 2 steps	2000	480	340 mm	80
extra step (max 10)	"	240	170 mm	33
CST2.5 2 steps	2500	480	340 mm	101
extra step (max 10)	"	240	170 mm	42
CST2.6 2 steps	3000	480	340 mm	119
extra step (max 10)	"	240	170 mm	49

Custom
Made
Possible



KG

AST2.1 2 steps	1000	480	340 mm	15
extra step (max 17)	"	240	170 mm	7
AST2.2 2 steps	1250	480	340 mm	17
extra step (max 17)	"	240	170 mm	8
AST2.3 2 steps	1500	480	340 mm	23
extra step (max 10)	"	240	170 mm	9
AST2.4 2 steps	2000	480	340 mm	28
extra step (max 10)	"	240	170 mm	12
AST2.5 2 steps	2500	480	340 mm	36
extra step (max 10)	"	240	170 mm	15
AST2.6 2 steps	3000	480	340 mm	43
extra step (max 10)	"	240	170 mm	17





Material
2 + 3 mm

Edging

We produce our edging in galvanised steel and Corten Steel. Available in five heights 100, 150, 200, 290 and 390mm and the thickness of the material can be 2 or 3 mm. The length of the strips is 2300 mm. You can also choose from simple straight strips or the top angle of 90 degrees or flattened (180 degrees).

5 year warranty



Roof support (PKV1)



Edging pegs (PK)

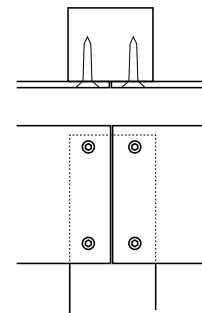

Edging pegs PK

PK 1 / 50x50x400 mm (25 pcs)

PK 2 / 50x50x600 mm (25 pcs)

PK 3 / 50x50x800 mm (25 pcs)

PKC1 / Steel 30x30x600 mm (25 pcs)

PKV1 / Steel roof support for 2mm edging

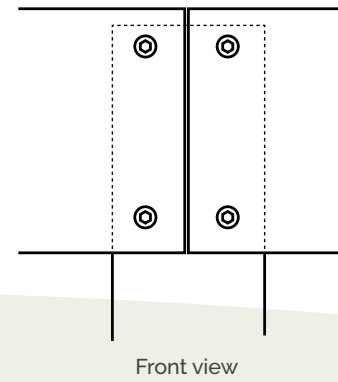
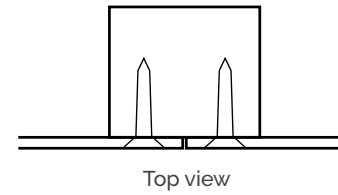
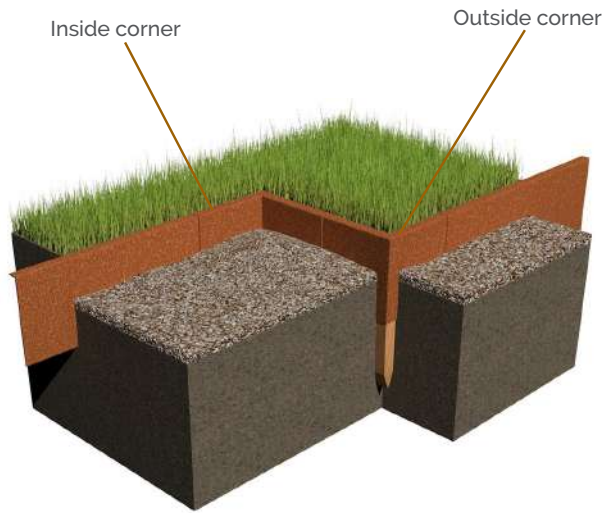

Edging straight
2300 X (H)100, 150, 200, 290 of 390



Edging put metal
2300 X (H)100, 150, 200, 290 of 390



Edging flattened
2300 X (H)100, 150, 200, 290 of 390

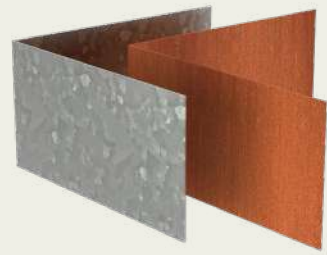

Corner inside or outside straight
300 X 300 (H)100, 150, 200, 290 of 390

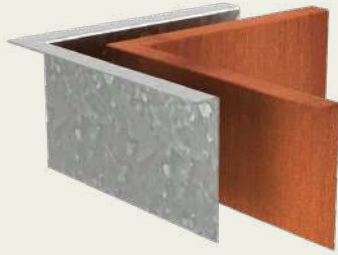

Corner inside or outside put metal
300 X 300 (H)100, 150, 200, 290 of 390



Corner inside or outside flattened
300 X 300 (H)100, 150, 200, 290 of 390



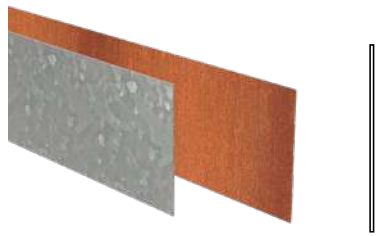

Edging straight (2300mm)



Edging put metal (2300mm)



Edging flattened (2300mm)

Height	Thickness	Strips	
100mm	2mm	25	C/VR2 100 25
		10	C/VR2 100 10
150mm	2mm	25	C/VR2 150 25
		10	C/VR2 150 10
	3mm	25	C/VR3 150 25
		10	C/VR3 150 10
200mm	2mm	25	C/VR2 200 25
		10	C/VR2 200 10
	3mm	25	C/VR3 200 25
		10	C/VR3 200 10
290mm	2mm	25	C/VR2 290 25
		10	C/VR2 290 10
	3mm	25	C/VR3 290 25
		10	C/VR3 290 10
390mm	2mm	25	C/VR2 390 25
		10	C/VR2 390 10
	3mm	25	C/VR3 390 25
		10	C/VR3 390 10

For Corten use code C
For Galvanised use code V

8 countersunk holes incl. TX-20 screws per strip, this is optional at additional cost.

Height	Thickness	Strips	
100mm	2mm	25	C/VZ2 100 25
		10	C/VZ2 100 10
150mm	2mm	25	C/VZ2 150 25
		10	C/VZ2 150 10
	3mm	25	C/VZ3 150 25
		10	C/VZ3 150 10
200mm	2mm	25	C/VZ2 200 25
		10	C/VZ2 200 10
	3mm	25	C/VZ3 200 25
		10	C/VZ3 200 10
290mm	2mm	25	C/VZ2 290 25
		10	C/VZ2 290 10
	3mm	25	C/VZ3 290 25
		10	C/VZ3 290 10
390mm	2mm	25	C/VZ2 390 25
		10	C/VZ2 390 10
	3mm	25	C/VZ3 390 25
		10	C/VZ3 390 10

For Corten use code C
For Galvanised use code V

8 countersunk holes incl. TX-20 screws per strip, this is optional at additional cost.

Height	Thickness	Strips	
100mm	2mm	25	C/VP2 100 25
		10	C/VP2 100 10
150mm	2mm	25	C/VP2 150 25
		10	C/VP2 150 10
	3mm	25	C/VP3 150 25
		10	C/VP3 150 10
200mm	2mm	25	C/VP2 200 25
		10	C/VP2 200 10
	3mm	25	C/VP3 200 25
		10	C/VP3 200 10
290mm	2mm	25	C/VP2 290 25
		10	C/VP2 290 10
	3mm	25	C/VP3 290 25
		10	C/VP3 290 10
390mm	2mm	25	C/VP2 390 25
		10	C/VP2 390 10
	3mm	25	C/VP3 390 25
		10	C/VP3 390 10

For Corten use code C
For Galvanised use code V

8 countersunk holes incl. TX-20 screws per strip, this is optional at additional cost.

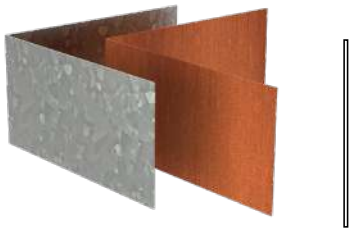

Corner straight (300x300mm)



Corner put metal (300x300mm)

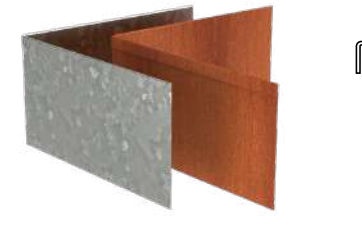

Corner flattened (300x300mm)

Height	Thickness	Corner	
100mm	2mm	outside	C/V R2 100 BU
		inside	C/V R2 100 BI
150mm	2mm	outside	C/V R2 150 BU
		inside	C/V R2 150 BI
	3mm	outside	C/V R3 150 BU
		inside	C/V R3 150 BI
200mm	2mm	outside	C/V R2 200 BU
		inside	C/V R2 200 BI
	3mm	outside	C/V R3 200 BU
		inside	C/V R3 200 BI
290mm	2mm	outside	C/V R2 290 BU
		inside	C/V R2 290 BI
	3mm	outside	C/V R3 290 BU
		inside	C/V R3 290 BI
390mm	2mm	outside	C/V R2 390 BU
		inside	C/V R2 390 BI
	3mm	outside	C/V R3 390 BU
		inside	C/V R3 390 BI

For Corten use code C
For Galvanised use code V

4 countersunk holes incl. TX-20 screws per corner element, optional at additional cost.

Height	Thickness	Corner	
100mm	2mm	outside	C/V Z2 100 BU
		inside	C/V Z2 100 BI
150mm	2mm	outside	C/V Z2 150 BU
		inside	C/V Z2 150 BI
	3mm	outside	C/V Z3 150 BU
		inside	C/V Z3 150 BI
200mm	2mm	outside	C/V Z2 200 BU
		inside	C/V Z2 200 BI
	3mm	outside	C/V Z3 200 BU
		inside	C/V Z3 200 BI
290mm	2mm	outside	C/V Z2 290 BU
		inside	C/V Z2 290 BI
	3mm	outside	C/V Z3 290 BU
		inside	C/V Z3 290 BI
390mm	2mm	outside	C/V Z2 390 BU
		inside	C/V Z2 390 BI
	3mm	outside	C/V Z3 390 BU
		inside	C/V Z3 390 BI

For Corten use code C
For Galvanised use code V

4 countersunk holes incl. TX-20 screws per corner element, optional at additional cost.

Height	Thickness	Corner	
100mm	2mm	outside	C/V P2 100 BU
		inside	C/V P2 100 BI
150mm	2mm	outside	C/V P2 150 BU
		inside	C/V P2 150 BI
	3mm	outside	C/V P3 150 BU
		inside	C/V P3 150 BI
200mm	2mm	outside	C/V P2 200 BU
		inside	C/V P2 200 BI
	3mm	outside	C/V P3 200 BU
		inside	C/V P3 200 BI
290mm	2mm	outside	C/V P2 290 BU
		inside	C/V P2 290 BI
	3mm	outside	C/V P3 290 BU
		inside	C/V P3 290 BI
390mm	2mm	outside	C/V P2 390 BU
		inside	C/V P2 390 BI
	3mm	outside	C/V P3 390 BU
		inside	C/V P3 390 BI

For Corten use code C
For Galvanised use code V

4 countersunk holes incl. TX-20 screws per corner element, optional at additional cost.





Retaining walls

With our range of retaining walls you can endlessly combine and almost any shape can be realised easily and quickly in your garden design. A prefab system which is easy to install with the supplied fasteners. These retaining walls have a top edge of 50x25mm as standard.

Options:

- Available in 2 different materials: Corten Steel and powder coated Aluminum
- Height: 200, 300, 400 and 600mm
- Straight pieces in length: 1000, 1500 and 2000mm
- Inside and outside corners, in lengths of 500 and 1000mm
- Inside and outside curves, with radius of 500, 1000, 1500 and 2000mm

Retaining walls are made to order therefore never in stock. Delivery time is 3 weeks.

5 year warranty

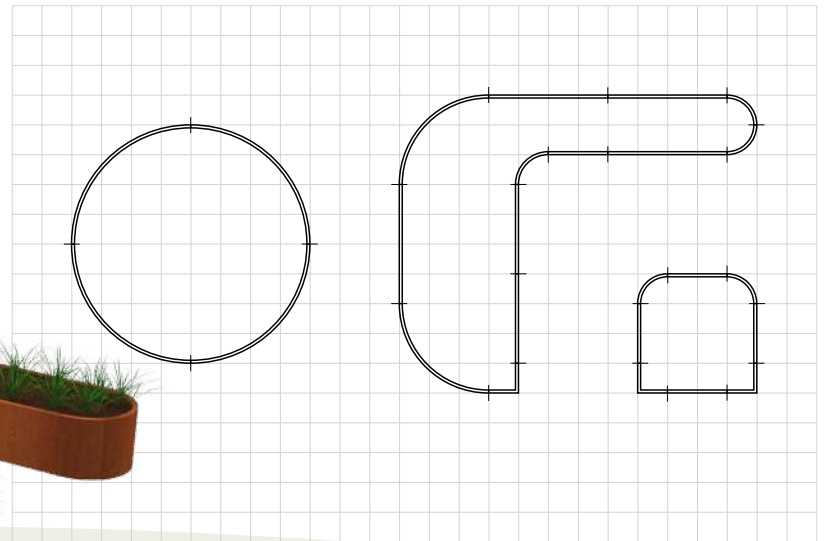

Retaining wall Straight
1000mm
1500mm
2000mm



Retaining wall Outside corner
500mm
1000mm

Retaining wall Inside corner
500mm
1000mm

Retaining wall Outside curve
500mm
1000mm
1500mm
2000mm

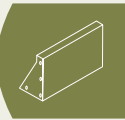
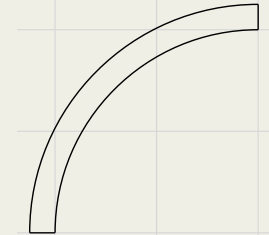
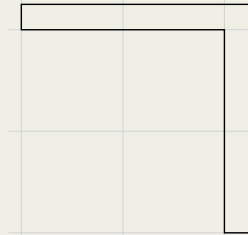
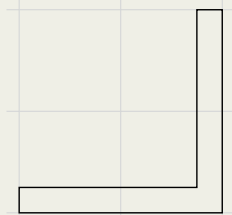
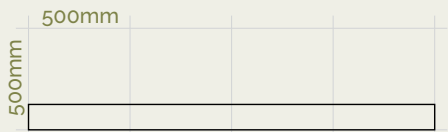

Retaining wall Inside curve
500mm
1000mm
1500mm
2000mm



CORTEN			KG
CRS2.200.1000 straight		1000	6
CRS2.200.1500 straight		1500	9
CRS2.200.2000 straight		2000	12
CRSN2.200.500 inside corner		500	6
CRSO2.200.500 outside corner		"	6
CRSN2.200.1000 inside corner		1000	11
CRSO2.200.1000 outside corner		"	11
	200		
CRCN2.200.500 inside curve		500	5
CRCO2.200.500 outside curve		"	4
CRCN2.200.1000 inside curve		1000	9
CRCO2.200.1000 outside curve		"	9
CRCN2.200.1500 inside curve		1500	13
CRCO2.200.1500 outside curve		"	13
CRCN2.200.2000 inside curve		2000	17
CRCO2.200.2000 outside curve		"	17



ALUMINIUM

ARS3.200.1000 straight		1000	3
ARS3.200.1500 straight		1500	4
ARS3.200.2000 straight		2000	6
ARSN3.200.500 inside corner		500	3
ARSO3.200.500 outside corner		"	3
ARSN3.200.1000 inside corner		1000	6
ARSO3.200.1000 outside corner		"	6
	200		
ARCN3.200.500 inside curve		500	2
ARCO3.200.500 outside curve		"	2
ARCN3.200.1000 inside curve		1000	4
ARCO3.200.1000 outside curve		"	4
ARCN3.200.1500 inside curve		1500	7
ARCO3.200.1500 outside curve		"	7
ARCN3.200.2000 inside curve		2000	9
ARCO3.200.2000 outside curve		"	9

CORTEN			KG
CRS2.300.1000 straight		1000	9
CRS2.300.1500 straight		1500	14
CRS2.300.2000 straight		2000	18
CRSN2.300.500 inside corner		500	8
CRSO2.300.500 outside corner		"	8
CRSN2.300.1000 inside corner		1000	16
CRSO2.300.1000 outside corner		"	15
	300		
CRCN2.300.500 inside curve		500	7
CRCO2.300.500 outside curve		"	6
CRCN2.300.1000 inside curve		1000	13
CRCO2.300.1000 outside curve		"	13
CRCN2.300.1500 inside curve		1500	19
CRCO2.300.1500 outside curve		"	19
CRCN2.300.2000 inside curve		2000	25
CRCO2.300.2000 outside curve		"	24



ALUMINIUM

ARS3.300.1000 straight		1000	4
ARS3.300.1500 straight		1500	6
ARS3.300.2000 straight		2000	8
ARSN3.300.500 inside corner		500	4
ARSO3.300.500 outside corner		"	4
ARSN3.300.1000 inside corner		1000	8
ARSO3.300.1000 outside corner		"	8
	300		
ARCN3.300.500 inside curve		500	3
ARCO3.300.500 outside curve		"	3
ARCN3.300.1000 inside curve		1000	6
ARCO3.300.1000 outside curve		"	6
ARCN3.300.1500 inside curve		1500	10
ARCO3.300.1500 outside curve		"	10
ARCN3.300.2000 inside curve		2000	13
ARCO3.300.2000 outside curve		"	13

CORTEN			KG
CRS3.400.1000 straight		1000	17
CRS3.400.1500 straight		1500	25
CRS3.400.2000 straight		2000	33
CRSN3.400.500 inside corner		500	18
CRSO3.400.500 outside corner		"	16
CRSN3.400.1000 inside corner		1000	33
CRSO3.400.1000 outside corner		"	31
	400		
CRCN3.400.500 inside curve		500	15
CRCO3.400.500 outside curve		"	13
CRCN3.400.1000 inside curve		1000	27
CRCO3.400.1000 outside curve		"	26
CRCN3.400.1500 inside curve		1500	40
CRCO3.400.1500 outside curve		"	38
CRCN3.400.2000 inside curve		2000	52
CRCO3.400.2000 outside curve		"	51

ALUMINIUM

ARS4.400.1000 straight		1000	8
ARS4.400.1500 straight		1500	12
ARS4.400.2000 straight		2000	15
ARSN4.400.500 inside corner		500	8
ARSO4.400.500 outside corner		"	7
ARSN4.400.1000 inside corner		1000	15
ARSO4.400.1000 outside corner		"	14
	400		
ARCN4.400.500 inside curve		500	6
ARCO4.400.500 outside curve		"	6
ARCN4.400.1000 inside curve		1000	12
ARCO4.400.1000 outside curve		"	11
ARCN4.400.1500 inside curve		1500	17
ARCO4.400.1500 outside curve		"	17
ARCN4.400.2000 inside curve		2000	23
ARCO4.400.2000 outside curve		"	22

CORTEN			KG
CRS3.600.1000 straight		1000	26
CRS3.600.1500 straight		1500	39
CRS3.600.2000 straight		2000	50
CRSN3.600.500 inside corner		500	24
CRSO3.600.500 outside corner		"	22
CRSN3.600.1000 inside corner		1000	44
CRSO3.600.1000 outside corner		"	42
	600		
CRCN3.600.500 inside curve		500	20
CRCO3.600.500 outside curve		"	18
CRCN3.600.1000 inside curve		1000	37
CRCO3.600.1000 outside curve		"	35
CRCN3.600.1500 inside curve		1500	54
CRCO3.600.1500 outside curve		"	53
CRCN3.600.2000 inside curve		2000	70
CRCO3.600.2000 outside curve		"	68

ALUMINIUM

ARS4.600.1000 straight		1000	11
ARS4.600.1500 straight		1500	16
ARS4.600.2000 straight		2000	21
ARSN4.600.500 inside corner		500	10
ARSO4.600.500 outside corner		"	10
ARSN4.600.1000 inside corner		1000	21
ARSO4.600.1000 outside corner		"	21
	600		
ARCN4.600.500 inside curve		500	7
ARCO4.600.500 outside curve		"	7
ARCN4.600.1000 inside curve		1000	14
ARCO4.600.1000 outside curve		"	14
ARCN4.600.1500 inside curve		1500	21
ARCO4.600.1500 outside curve		"	21
ARCN4.600.2000 inside curve		2000	28
ARCO4.600.2000 outside curve		"	28

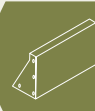



Accessories

All our accessories meet the highest standards and are a perfect fit to our products.



Cleaner and protector



Descaler



Rust accelerator



Corten Varnish



Overflow pipe



Edging pegs (PK)



Roof support (PKV1)

OVL	Overflow pipe Ø22mm x H. 50mm
POL	Cleaner + Protector
CORT	Rust accelerator
ALU	Descaler
COR 0,5	Finish for Corten steel Owatrol 0,5 ltr.
COR 5,0	Finish for Corten steel Owatrol 5,0 ltr.
PK1	50x50x400 mm (25 pcs)
PK2	50x50x600 mm (25 pcs)
PK3	50x50x800 mm (25 pcs)
PKC1	30x30x600 mm (25 pcs) 2 mm Steel edging pegs
PKV1	3 mm Steel roof support



ADEZZ[®]

WE PRODUCE GARDEN PRODUCTS FOR PROFESSIONALS

ADEZZ[®]

Production, distribution and sales
Liessentstraat 4, 5405 AG Uden
the Netherlands
t. +31 (0)413 745 423
www.adezz.uk info@adezz.uk

